

	Chaussee	Circle
A (mm)	965	965
B (mm)	1500/1700	1500/1700
C (mm)	840/1040	840/1040
D (mm)	880	880
E (mm)	1000/1200	1000/1200
F (mm)	60	60
G (mm)	35	35
H (mm)	50	50

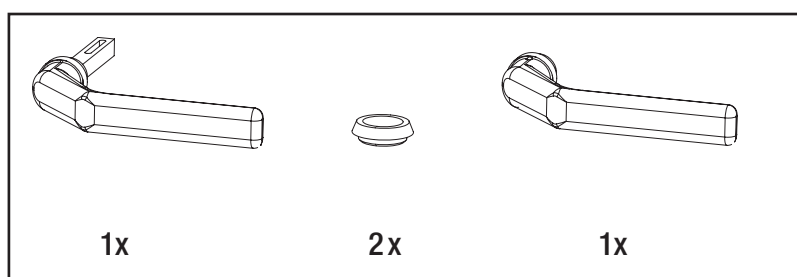

1.2

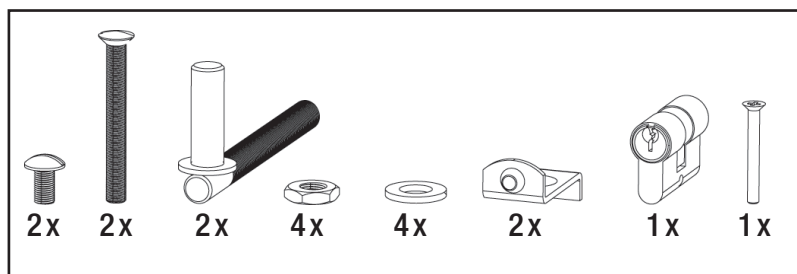
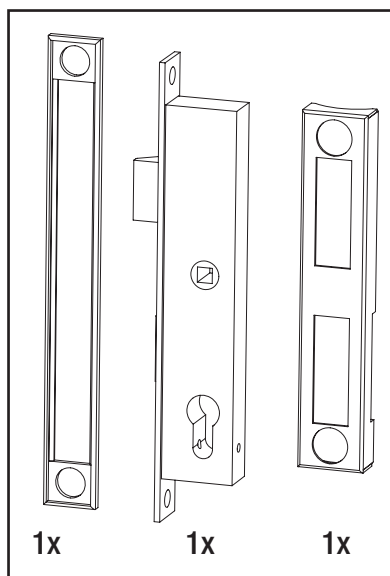
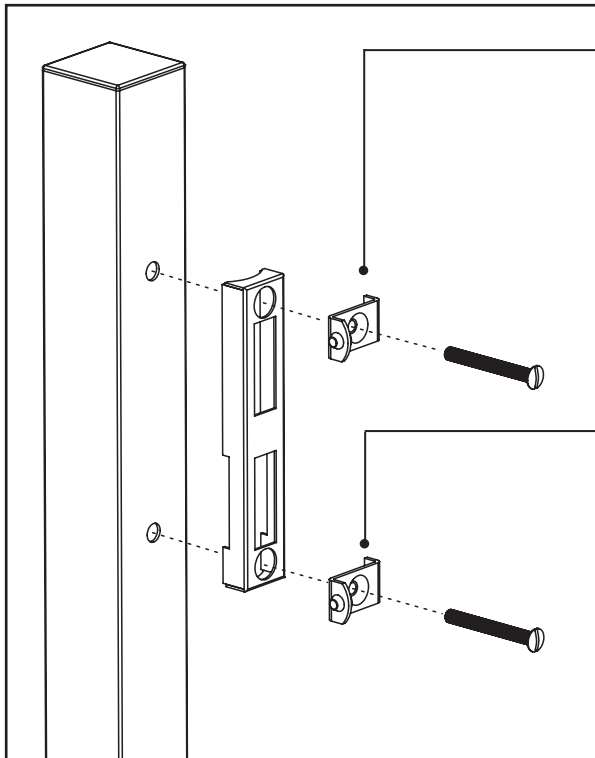

1.1

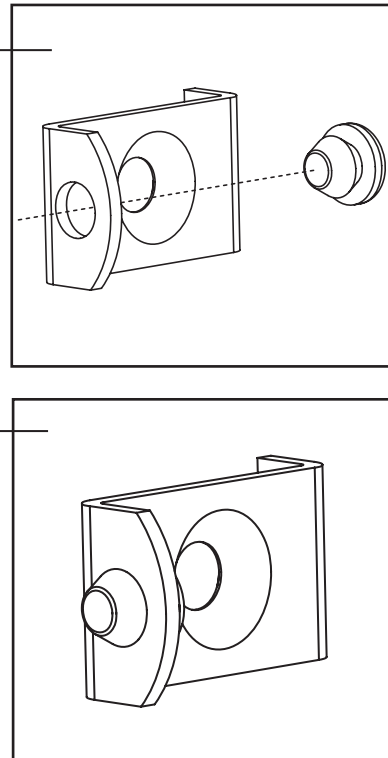

2.1

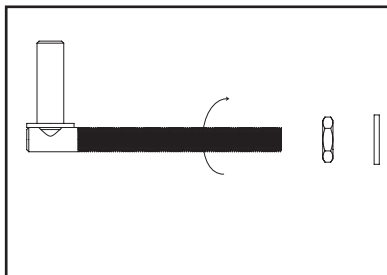

2.3

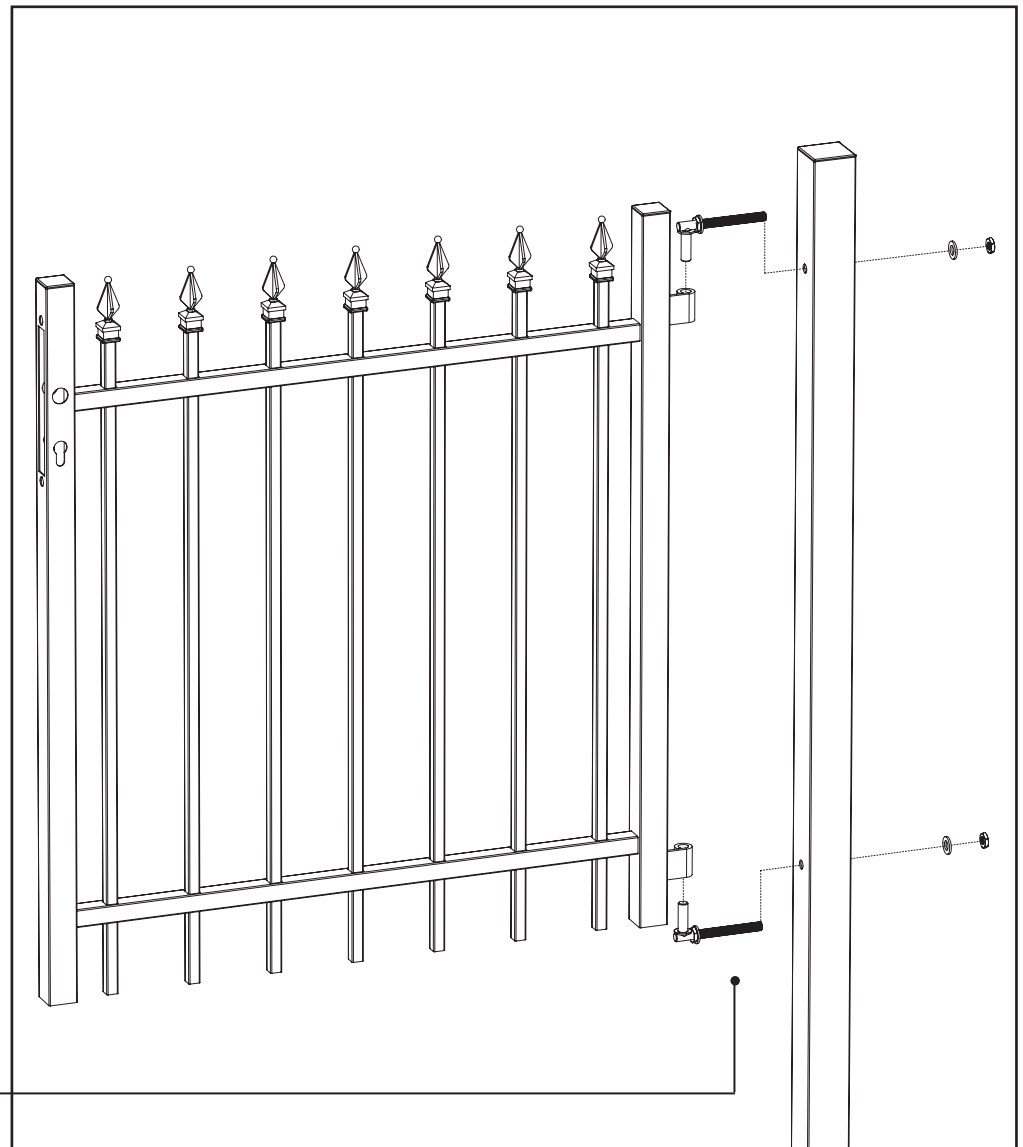

2.2

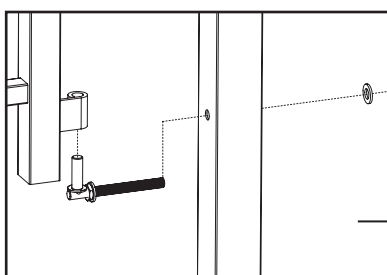
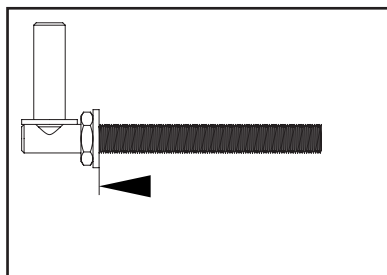

3.1

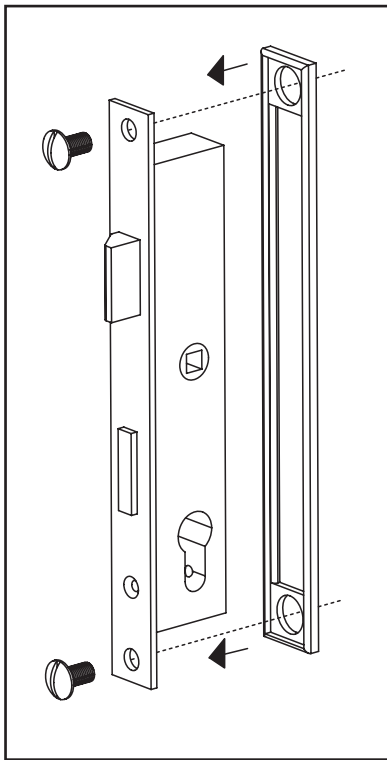

3.2

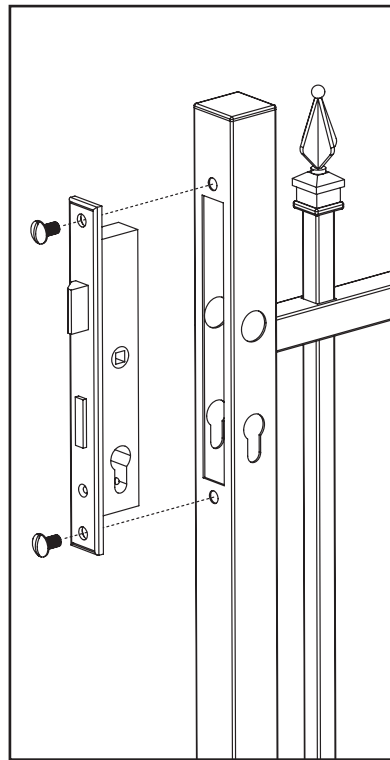

3.3

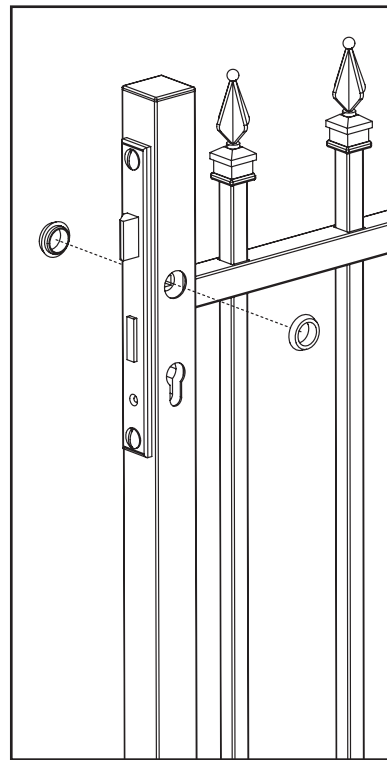

3.4

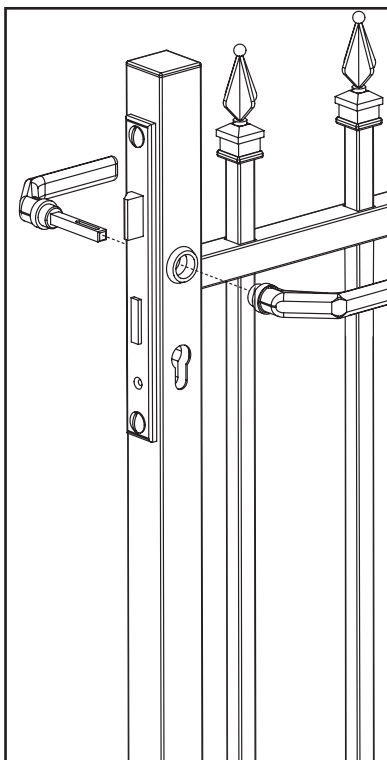

3.5

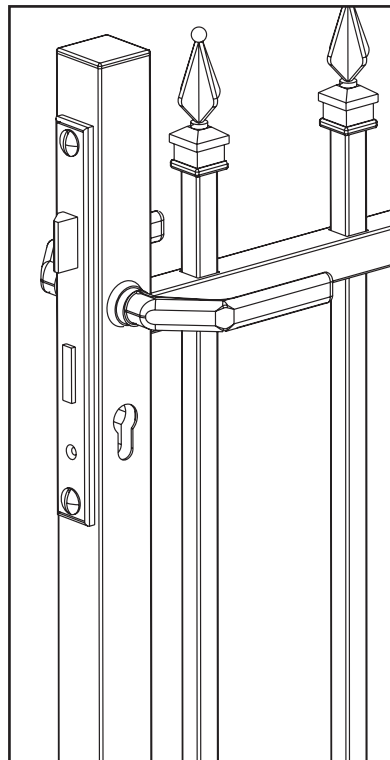

3.6

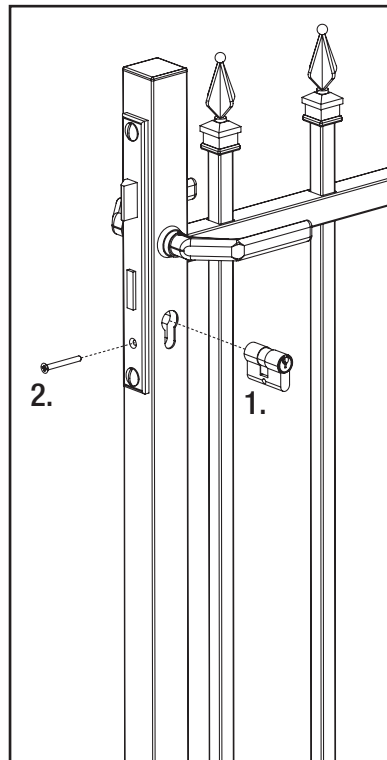

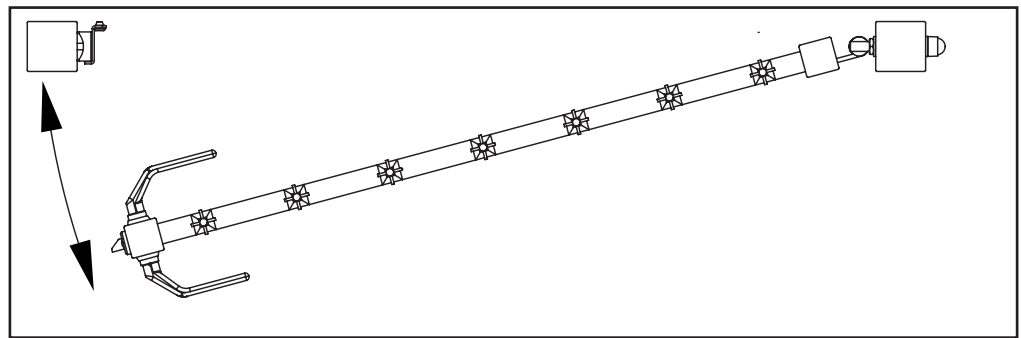
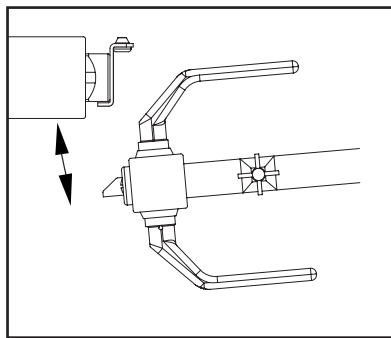
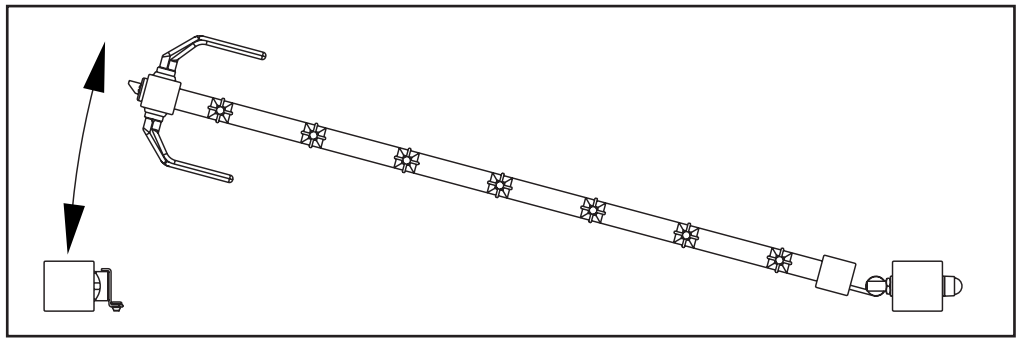
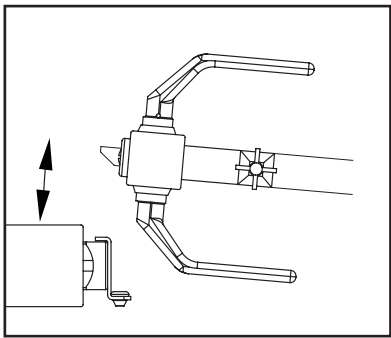

3.7

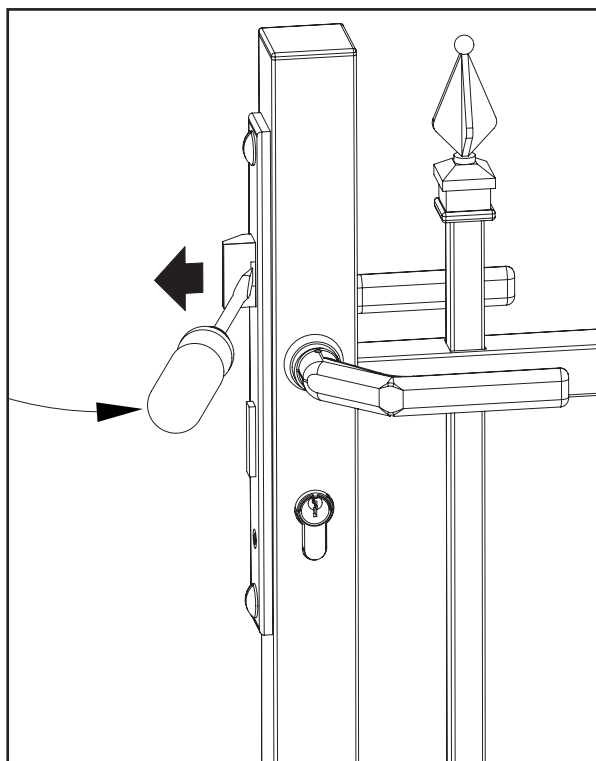

3.8

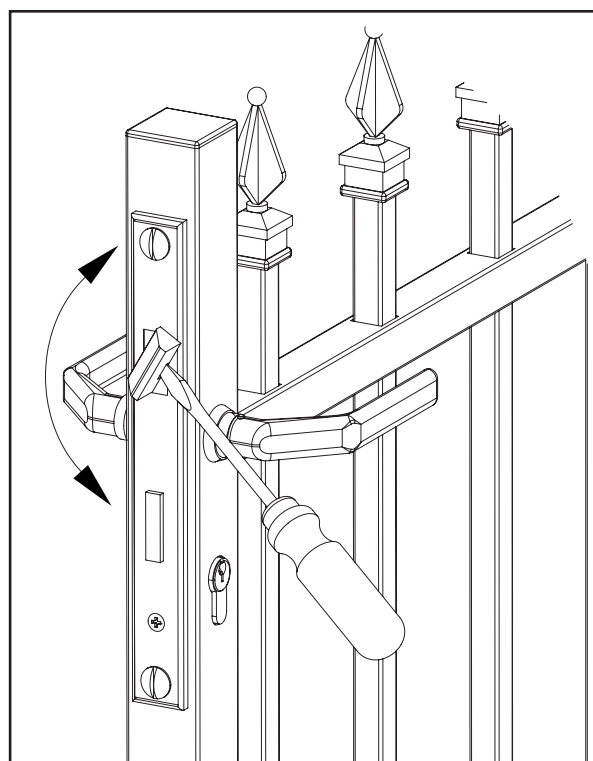

4.1

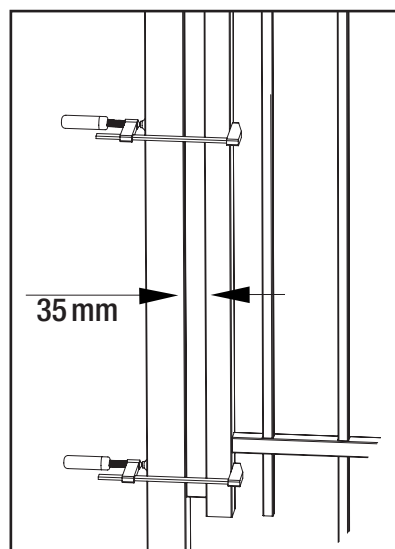

4.2

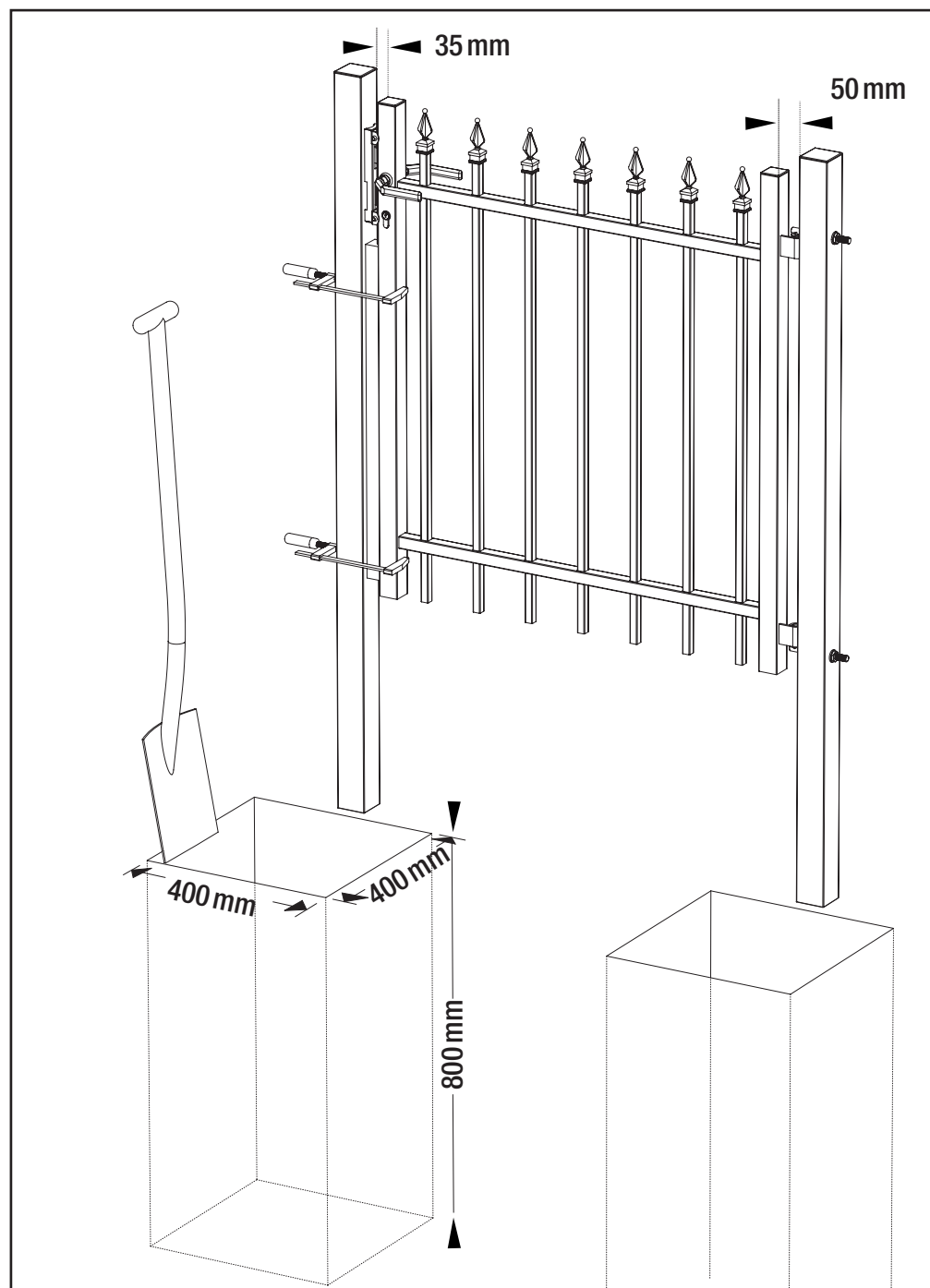

5.1

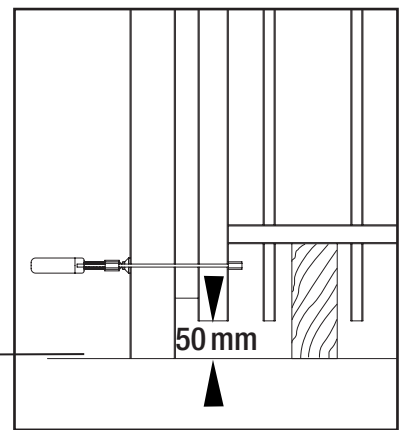
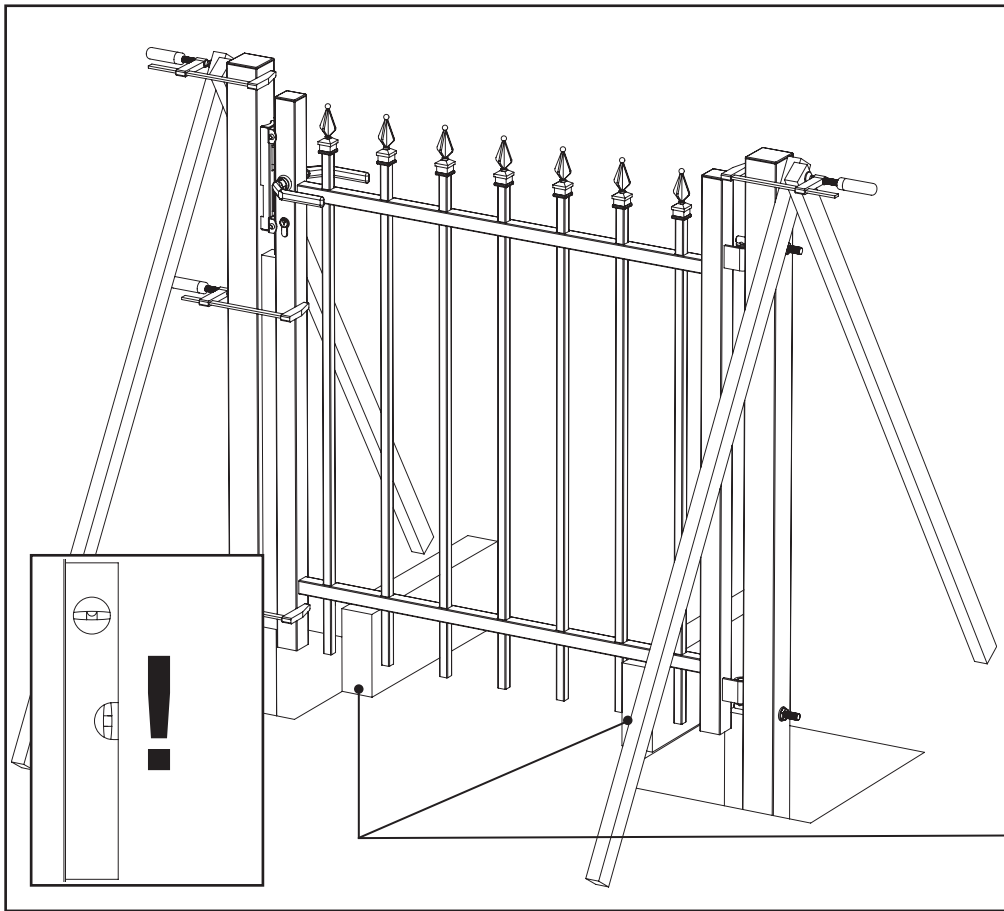

6.1

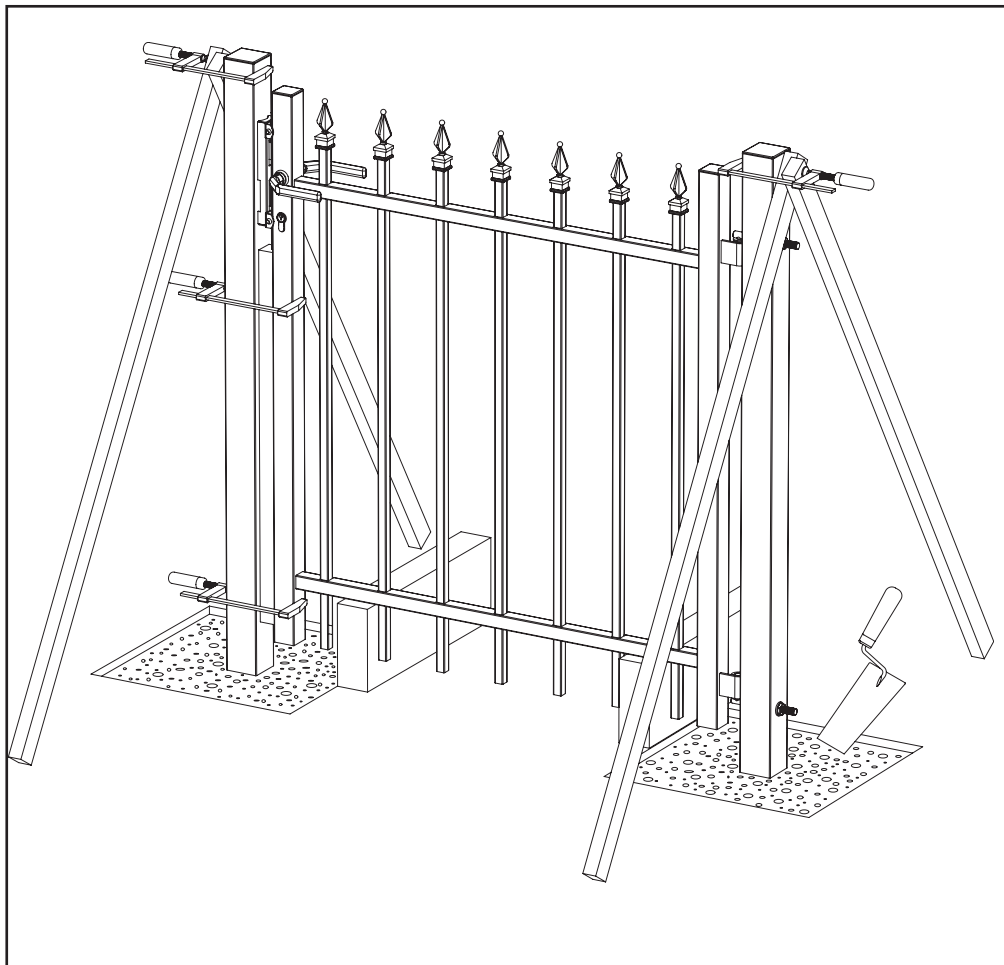

7.1

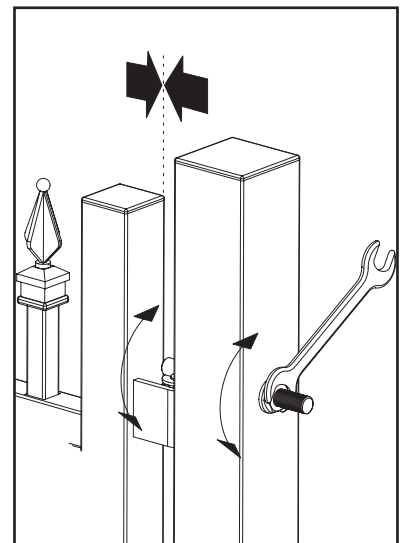

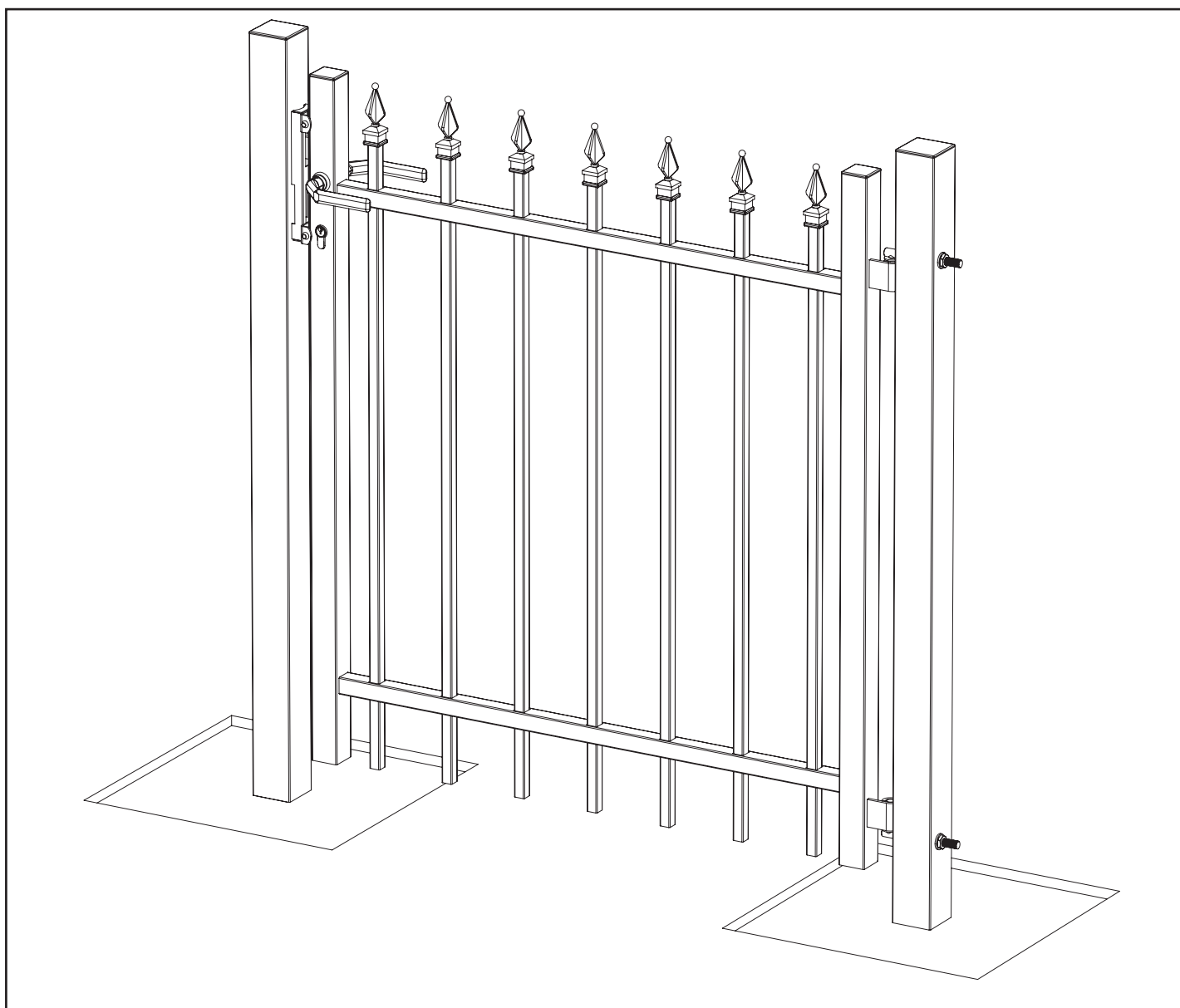

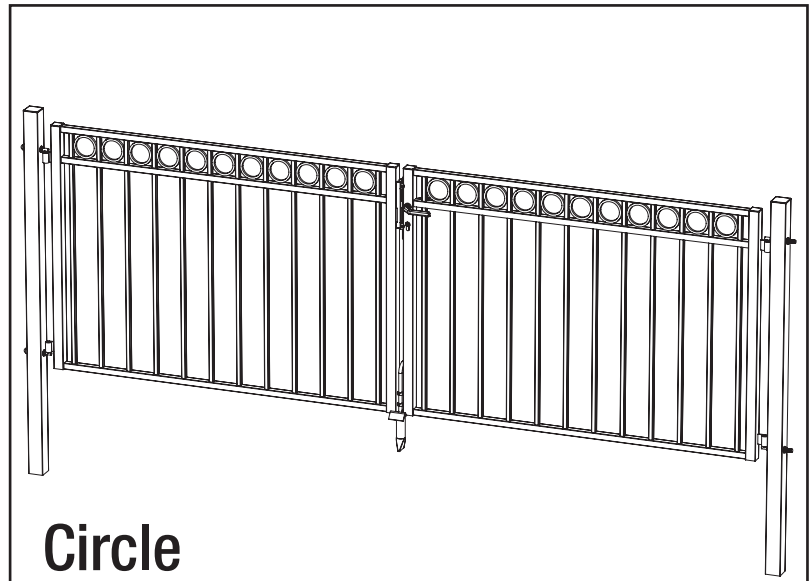
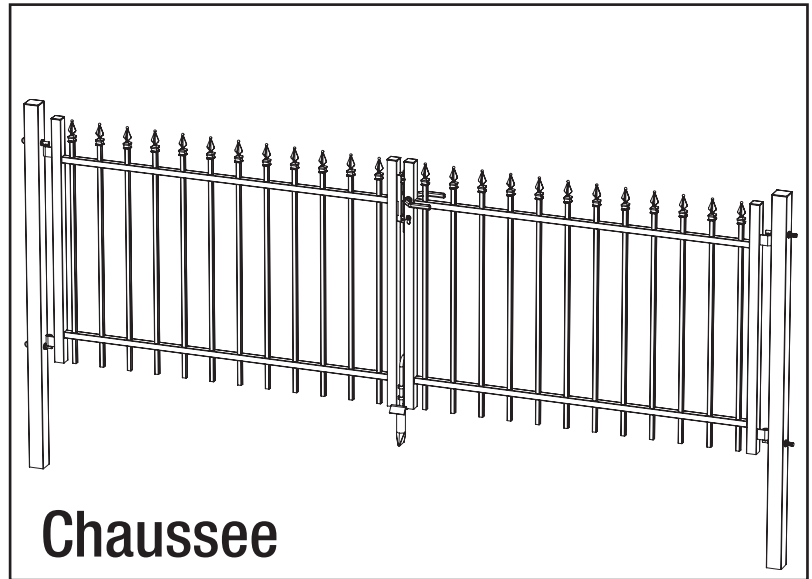

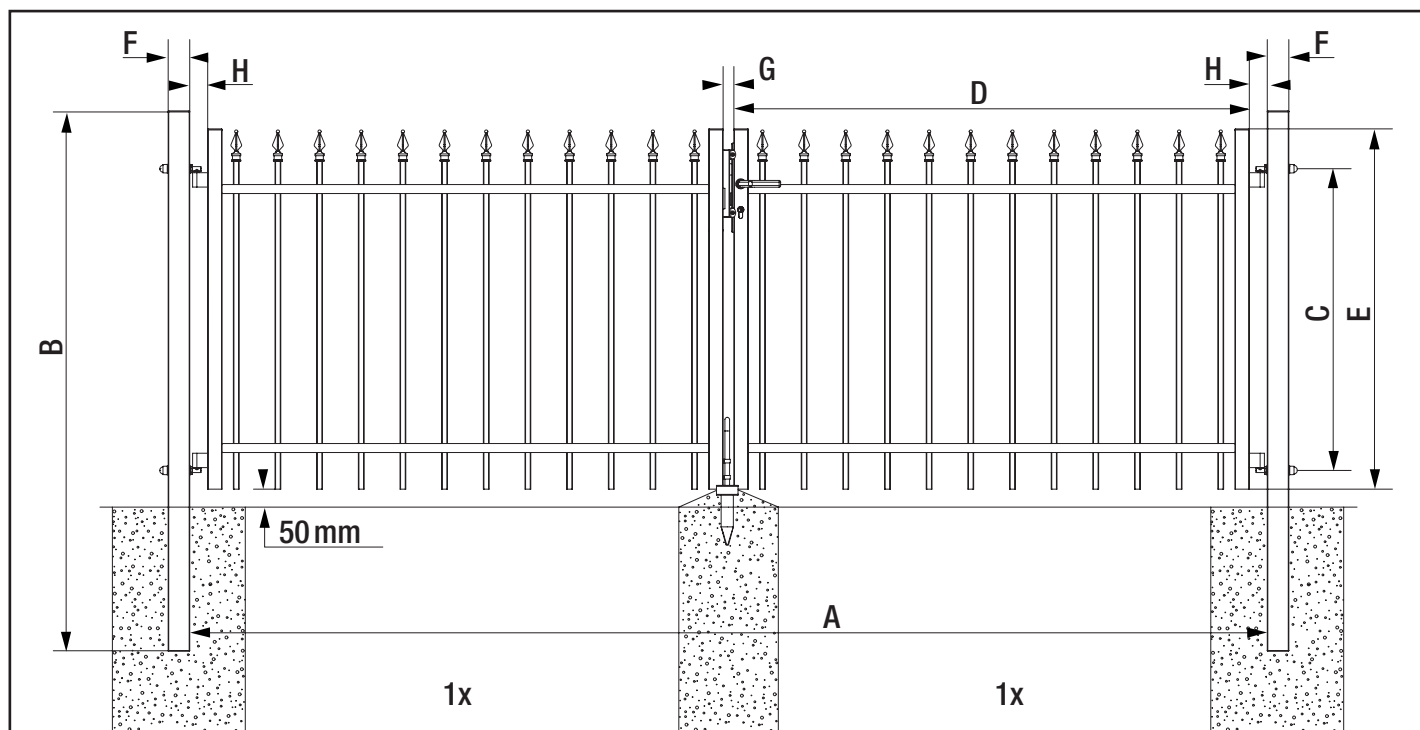

	Chaussee	Circle
A (mm)	3010	3010
B (mm)	1500/1700	1500/1700
C (mm)	840/1040	840/1040
D (mm)	1435	1435
E (mm)	1000/1200	1000/1200
F (mm)	60	60
G (mm)	35	35
H (mm)	50	50

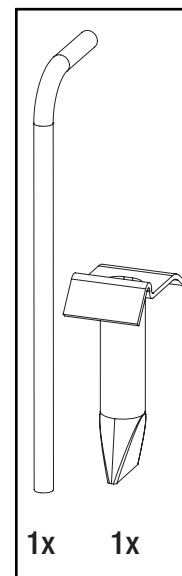
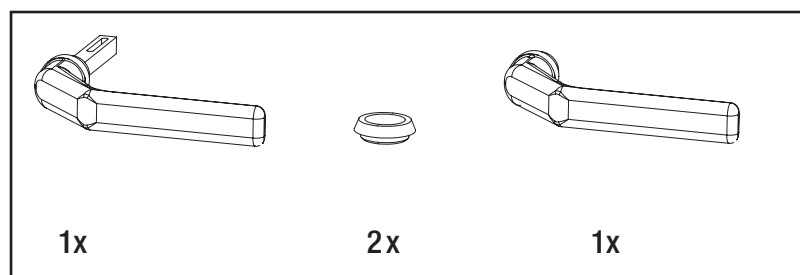
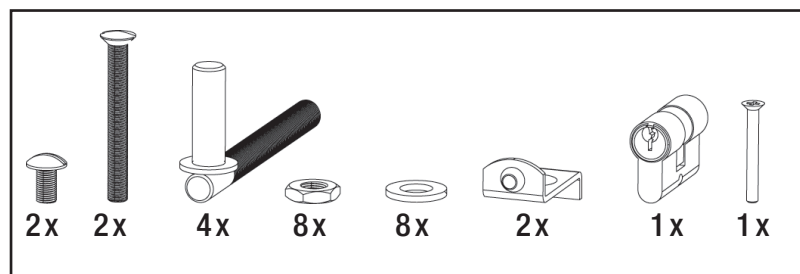
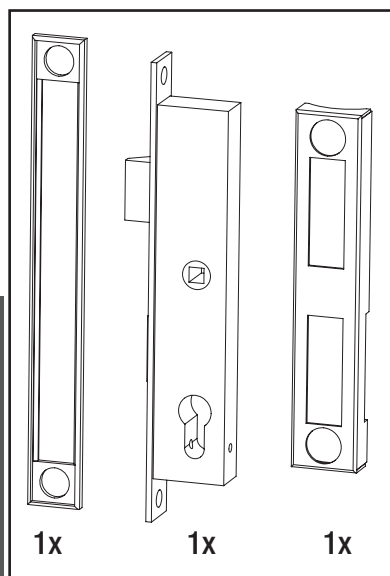

1.1

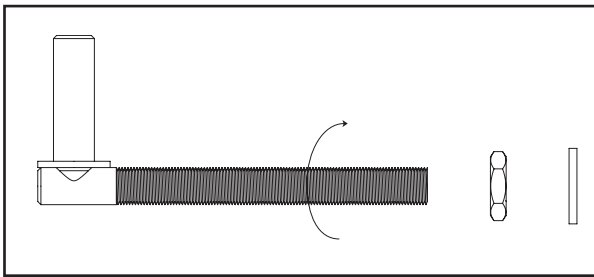

1.2

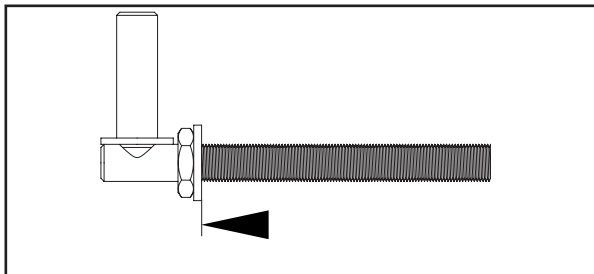

1.3

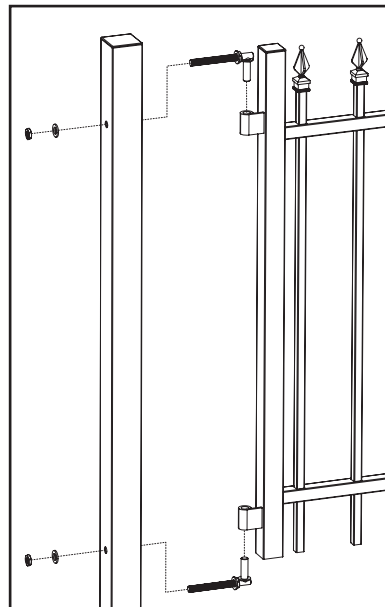

1.4

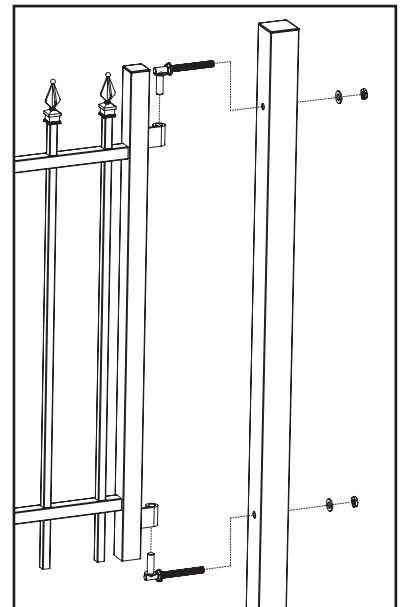

2.2

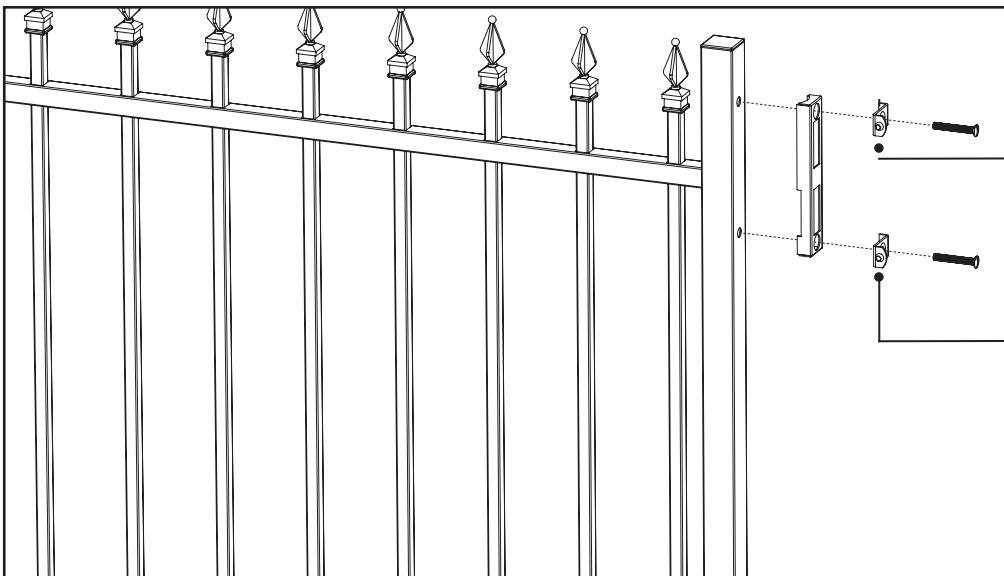

2.1

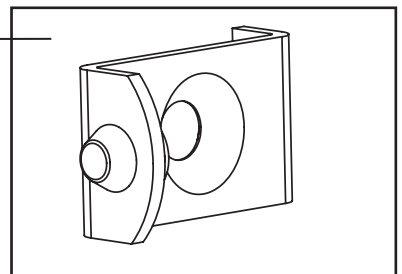
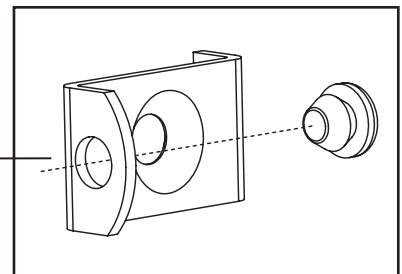

2.3

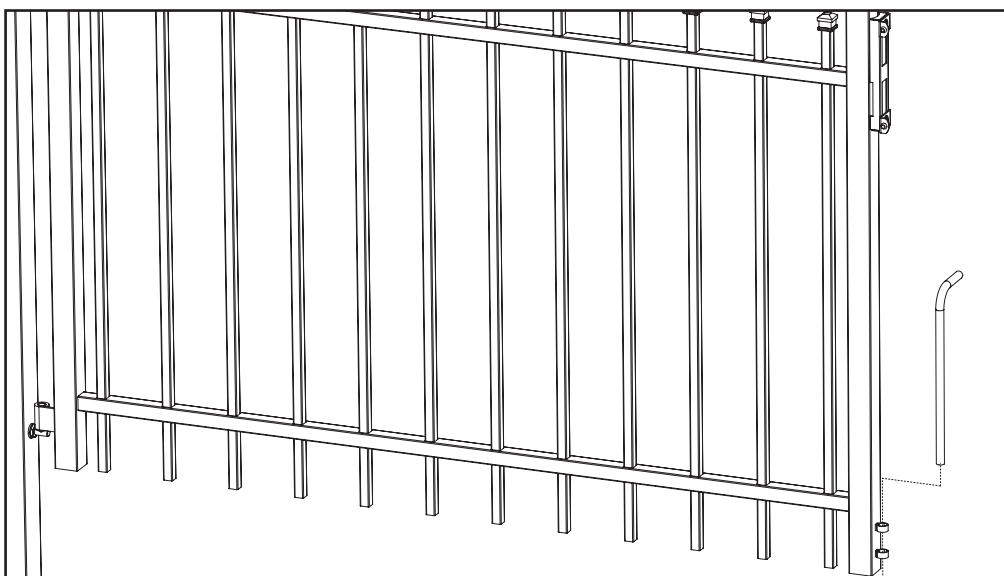

3.1

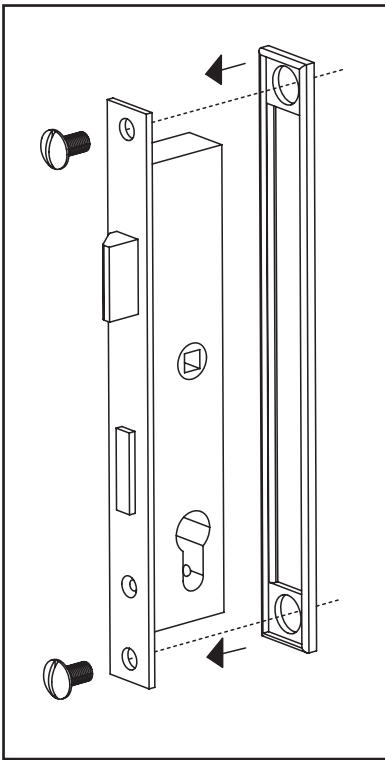

3.2

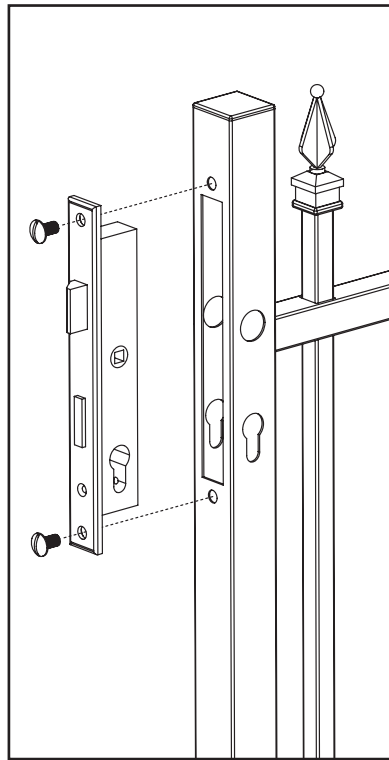

3.3

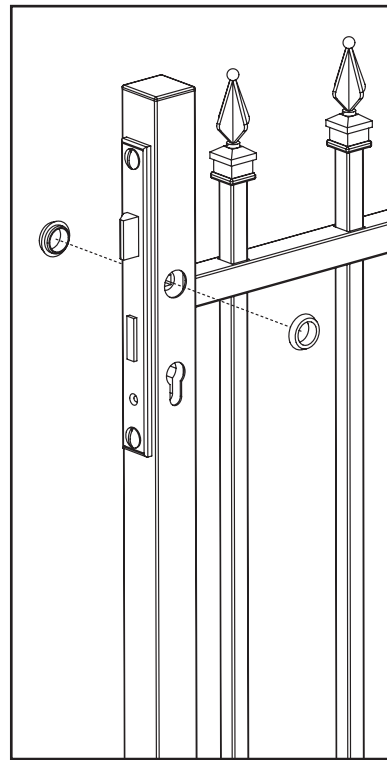

3.4

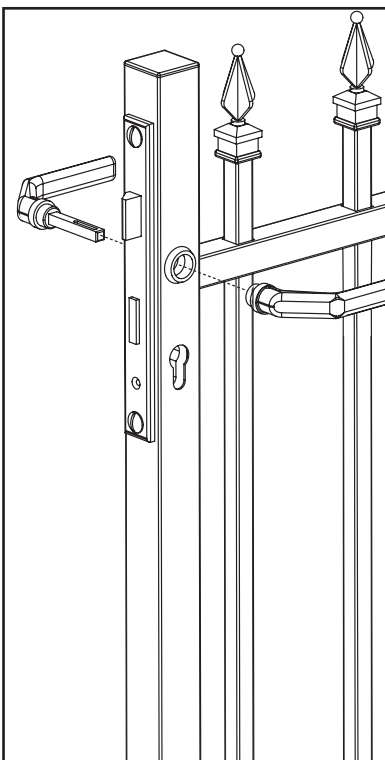

3.5

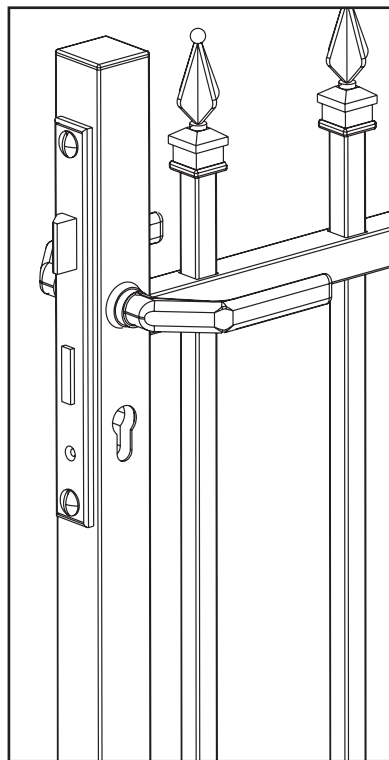

3.6

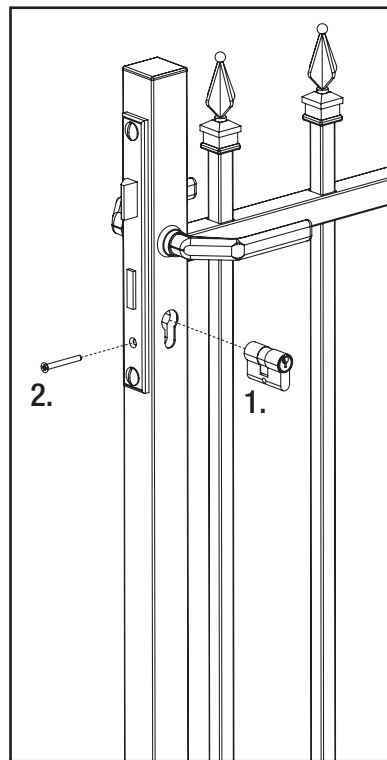

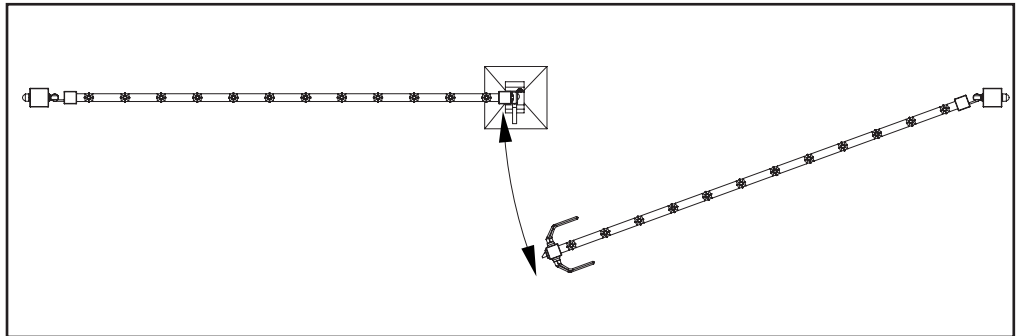
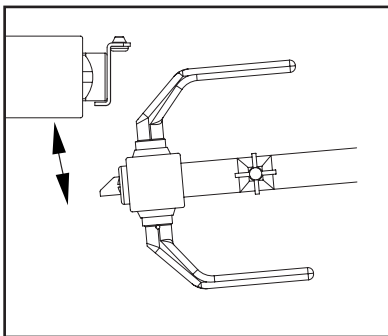
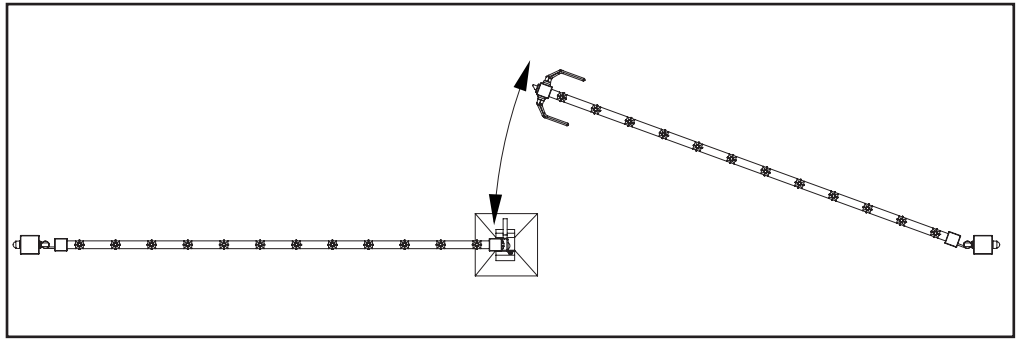
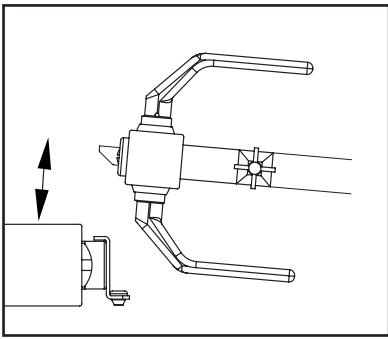

3.7

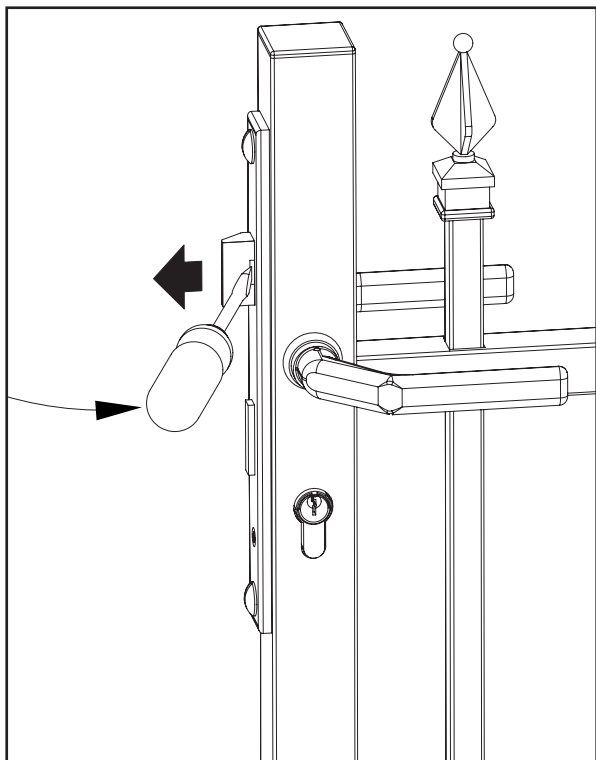

3.8

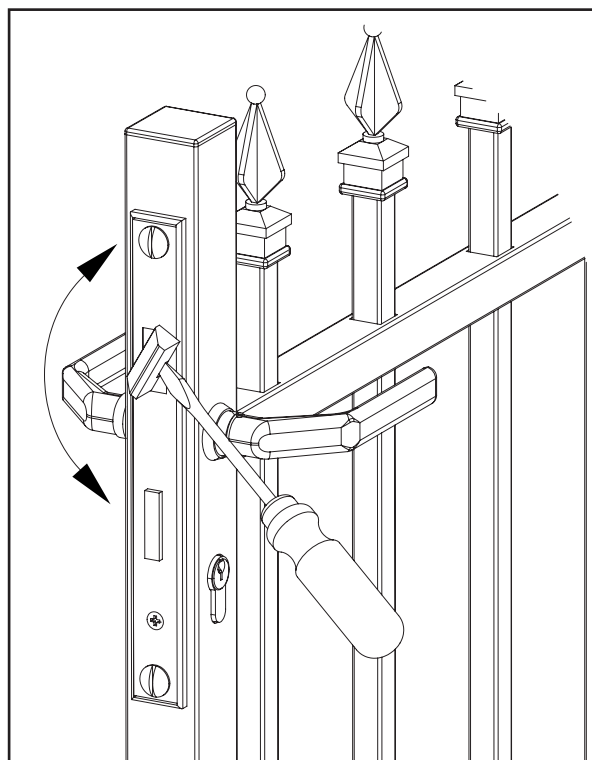

4.1

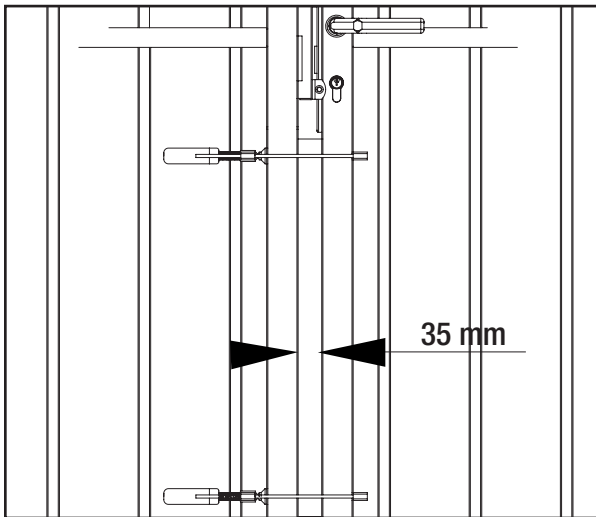

4.2

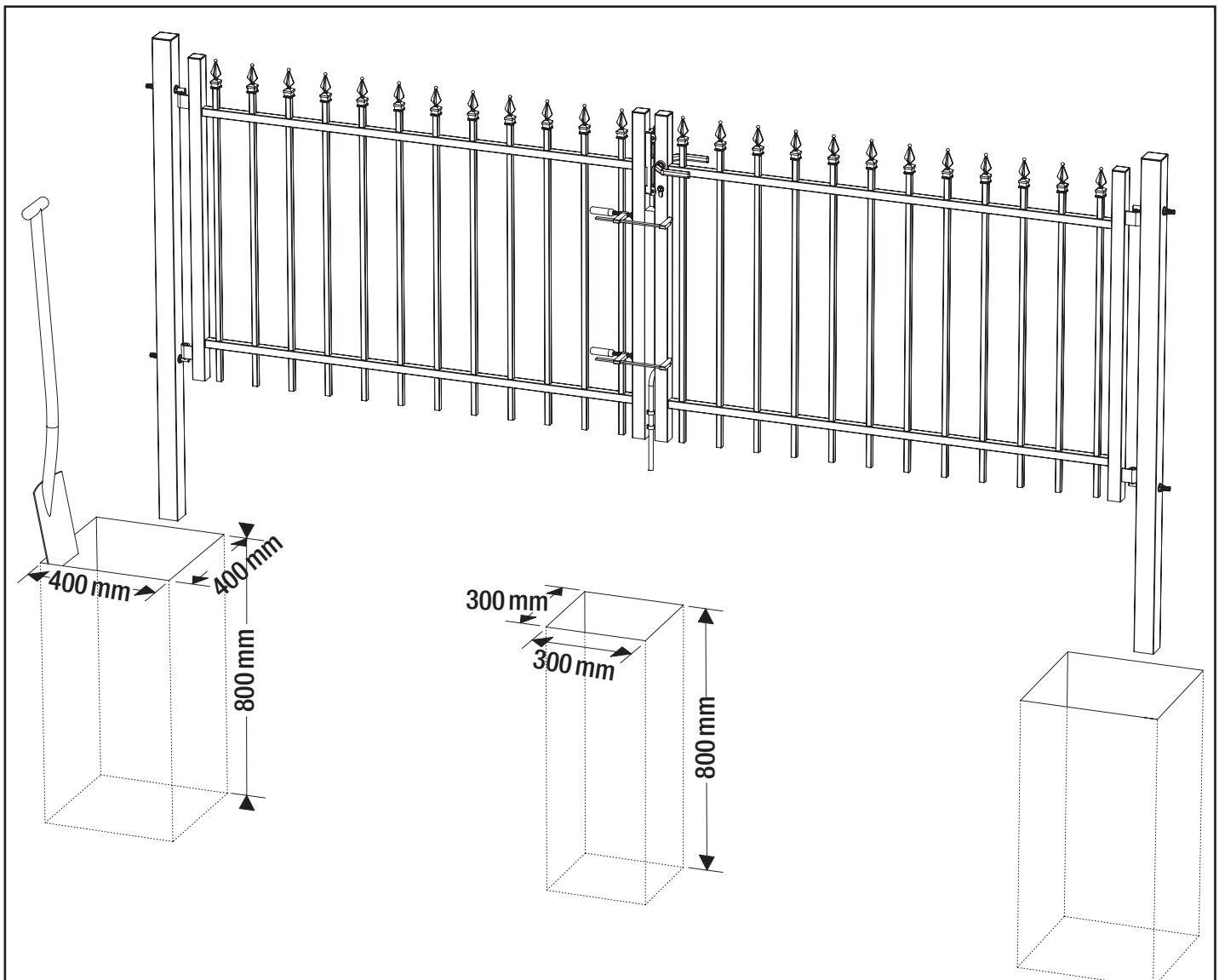

5.1

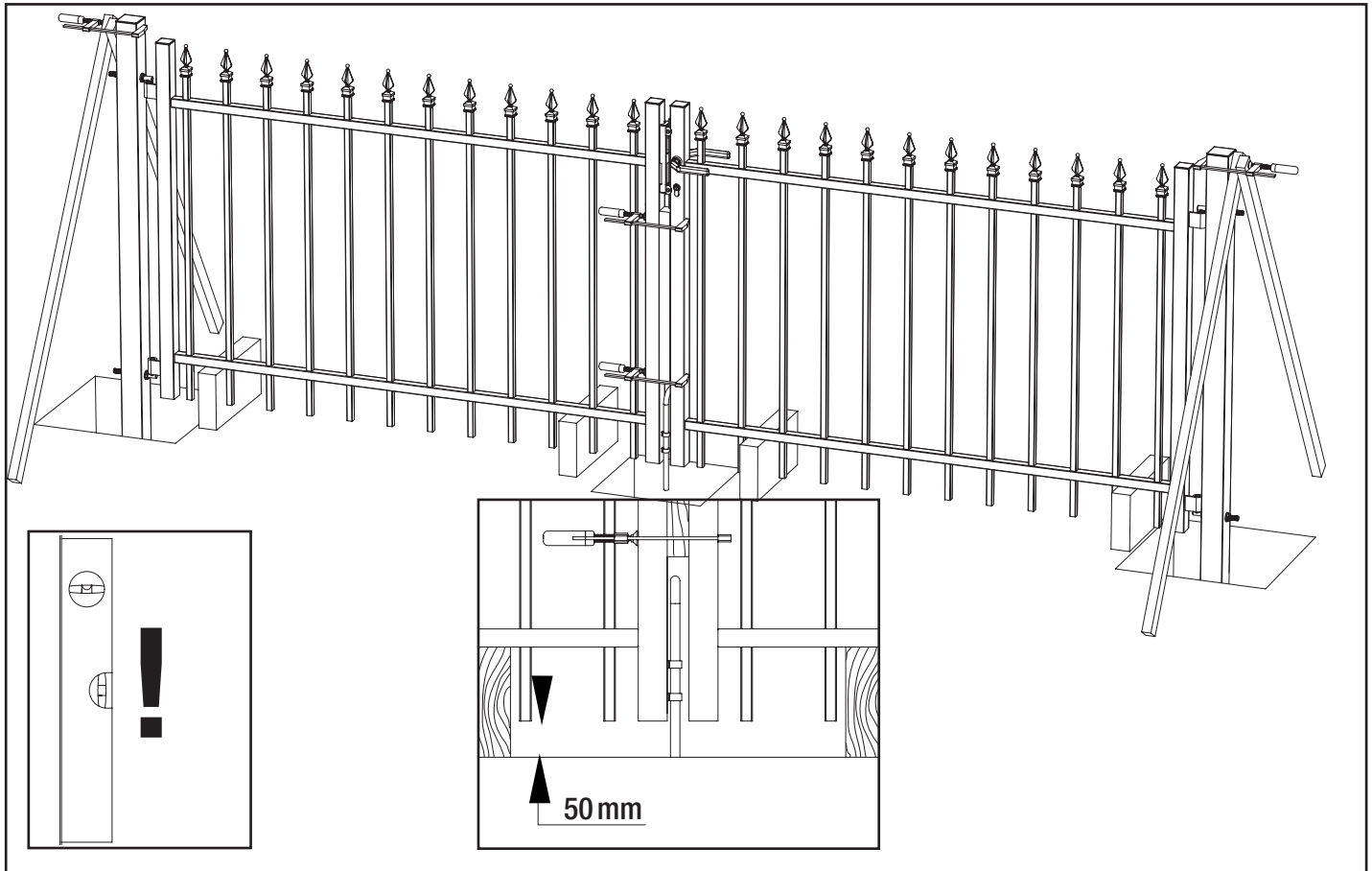

6.1

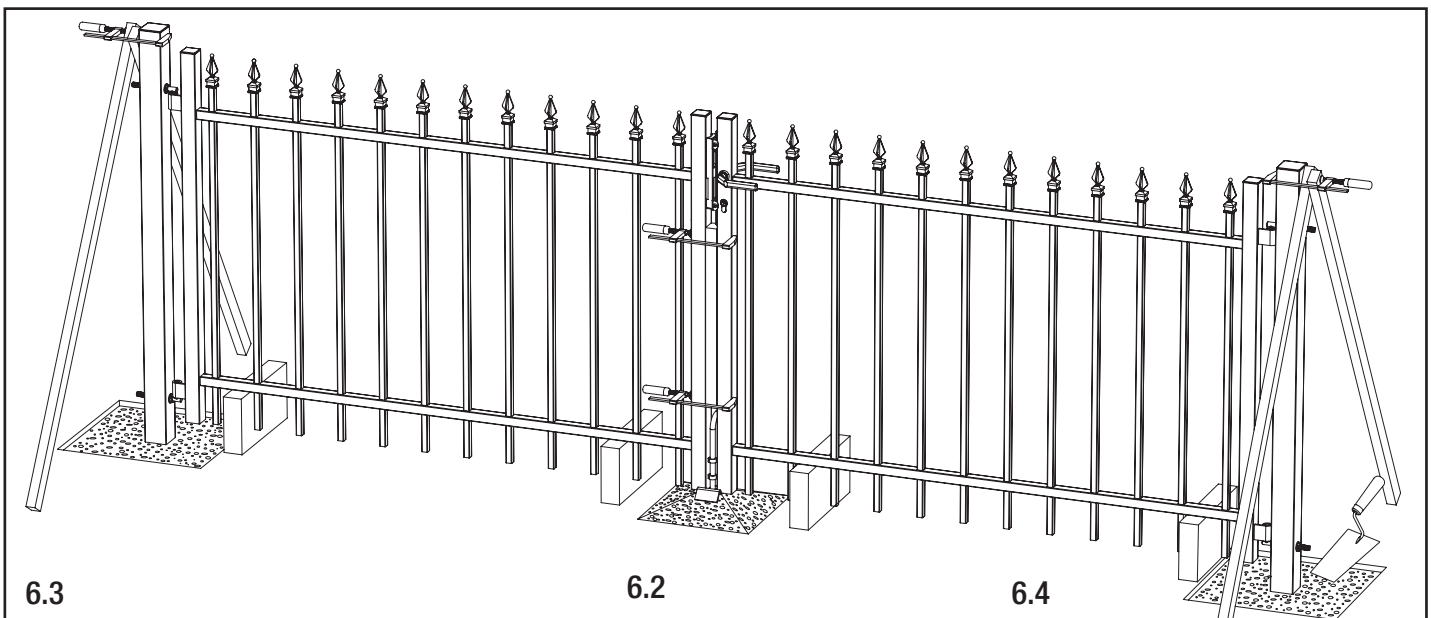

6.3

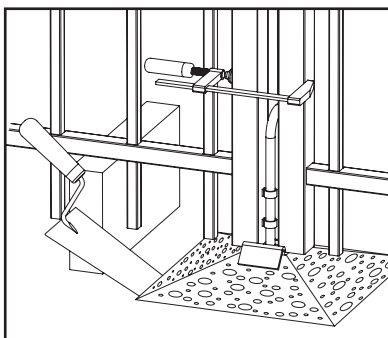

6.2

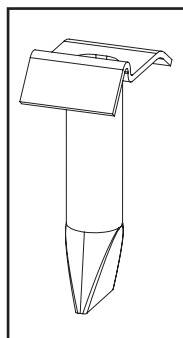

6.4

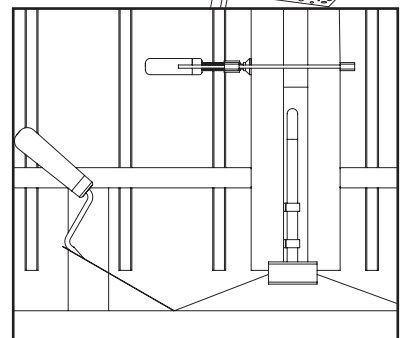

7.1

