

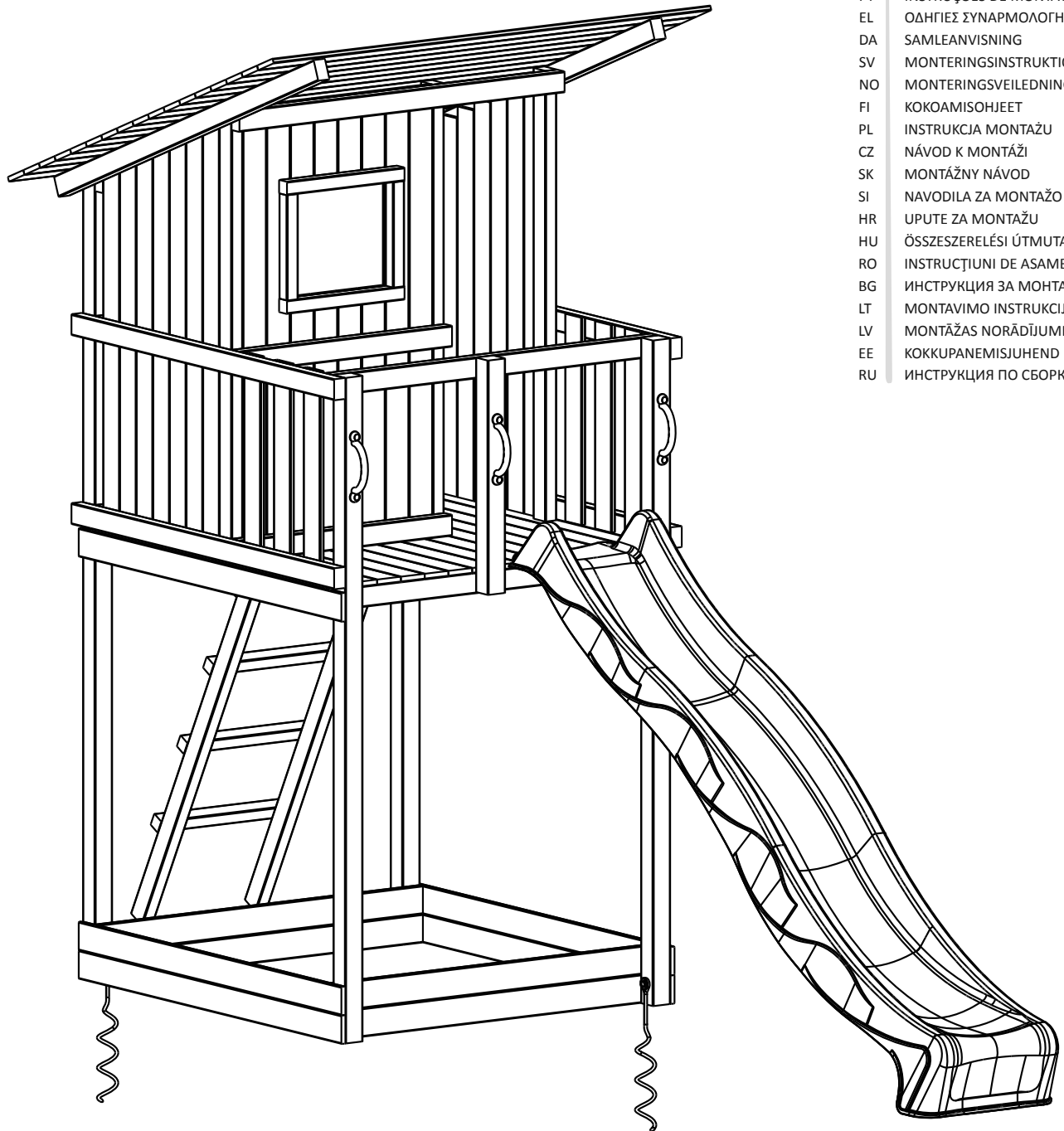

Beach Hut



EN	ASSEMBLY INSTRUCTIONS
DE	MONTAGEANLEITUNGEN
FR	INSTRUCTIONS DE MONTAGE
ES	INSTRUCCIONES DE MONTAJE
IT	ISTRUZIONI PER L'ASSEMBLAGGIO
NL	MONTAGE INSTRUCTIES
PT	INSTRUÇÕES DE MONTAGEM
EL	ΟΔΗΓΙΕΣ ΣΥΝΑΡΜΟΛΟΓΗΣΗΣ
DA	SAMLEANVISNING
SV	MONTERINGSINSTRUKTIONER
NO	MONTERINGSVEILEDNING
FI	KOKOAMISOHJEET
PL	INSTRUKCJA MONTAŻU
CZ	NÁVOD K MONTÁŽI
SK	MONTÁŽNY NÁVOD
SI	NAVODILA ZA MONTAŽO
HR	UPUTE ZA MONTAŽU
HU	ÖSSZESZERELÉSI ÚTMUTATÓ
RO	INSTRUCȚIUNI DE ASAMBLARE
BG	ИНСТРУКЦИЯ ЗА МОНТАЖ
LT	MONTAVIMO INSTRUKCIJA
LV	MONTĀŽAS NORĀDĪJUMI
EE	KOKKUPANEMISUJUHEND
RU	ИНСТРУКЦИЯ ПО СБОРКЕ

blue rabbit 2.0











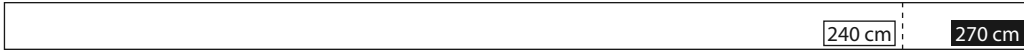











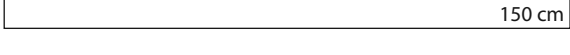



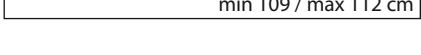

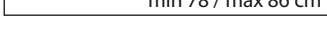

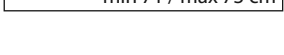



IM008.001.003-v02 (2015-06)

© 2014

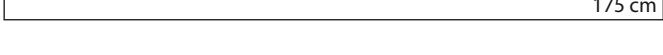
Blue Rabbit 2.0 - Hemelrijken 8 - B-2890 St-Amands - Belgium.
Copyrighted material - Do not reproduce under penalty of law.



EN 71-1, 2, 3 & 8

- 2x** **A** min 68 mm max 90 mm  
min 68 mm max 90 mm
- 2x** **B** min 68 mm max 90 mm  
min 68 mm max 90 mm
- 1x** **C** min 68 mm max 90 mm  
min 68 mm max 90 mm
- 1x** **D** min 68 mm max 90 mm  
min 68 mm max 90 mm
- 2x** **E** min 68 mm max 90 mm  
min 32 mm max 50 mm
- 2x** **F** min 68 mm max 90 mm  
min 32 mm max 50 mm
- 7x** **G** min 68 mm max 90 mm  
min 32 mm max 50 mm
- 6x** **H** min 68 mm max 90 mm  
min 32 mm max 50 mm
- 1x** **I** min 68 mm max 90 mm  
min 32 mm max 50 mm
- 2x** **J** min 68 mm max 90 mm  
min 32 mm max 50 mm
- 2x** **K** min 68 mm max 90 mm  
min 32 mm max 50 mm
- 2x** **L** min 44 mm max 45 mm  
min 44 mm max 45 mm
- 3x 4x** **M** min 44 mm max 45 mm  
min 44 mm max 45 mm
- 2x** **N** min 44 mm max 45 mm  
min 44 mm max 45 mm
- 11x*/17x**** **O** ** min 95 mm * max 145 mm  
min 15 mm max 22 mm
- 8x*/10x**** **P** ** min 95 mm * max 145 mm  
min 15 mm max 22 mm
- 10x*/14x**** **Q** ** min 95 mm * max 145 mm  
min 15 mm max 22 mm
- 4x** **R** min 95 mm max 145 mm  
min 15 mm max 22 mm

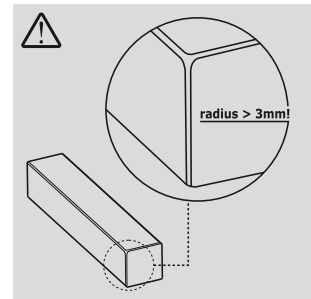
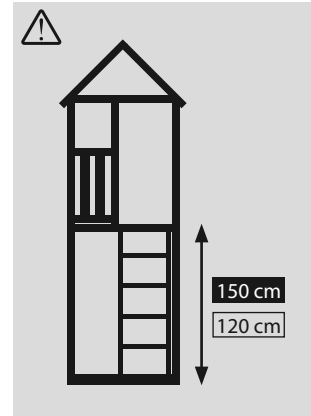

5x*/8x** **S** ** min 95 mm
* max 145 mm



118 cm

min 15 mm
max 22 mm

3x*/4x** **T** ** min 95 mm
* max 145 mm



85 cm

min 15 mm
max 22 mm

4x*/6x** **U** ** min 95 mm
* max 145 mm



69 cm

min 15 mm
max 22 mm

3x*/4x** **V** ** min 95 mm
* max 145 mm



30 cm

min 15 mm
max 22 mm

α

	95 mm	120 mm	145 mm
--	-------	--------	--------

2x **1** **α**

122 cm	122 cm	122 cm
--------	--------	--------

min 15 mm
max 22 mm

2x **2** **α**

126 cm	125 cm	128 cm
--------	--------	--------

min 15 mm
max 22 mm

2x **3** **α**

130 cm	130 cm	133 cm
--------	--------	--------

min 15 mm
max 22 mm

2x **4** **α**

134 cm	135 cm	139 cm
--------	--------	--------

min 15 mm
max 22 mm

2x **5** **α**

137 cm	140 cm	145 cm
--------	--------	--------

min 15 mm
max 22 mm

2x **6** **α**

141 cm	145 cm	-
--------	--------	---

min 15 mm
max 22 mm

2x **7** **α**

145 cm	-	-
--------	---	---

min 15 mm
max 22 mm

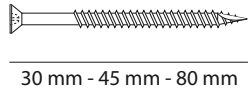
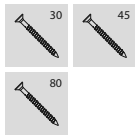

30 mm - 45 mm - 80 mm

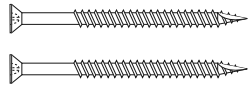

45 mm - 80 mm

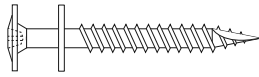

80 mm

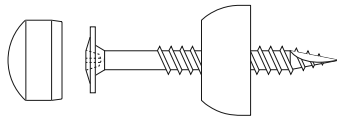

80 mm

6x

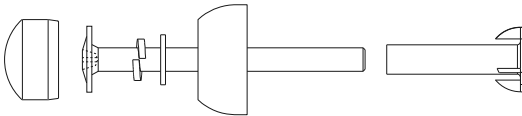

70 mm

4x

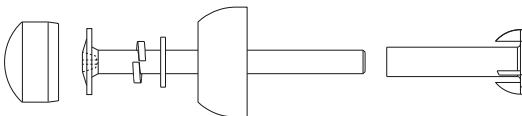

90 / 110 mm

2x

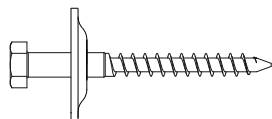

70 mm

5x



2x







1x

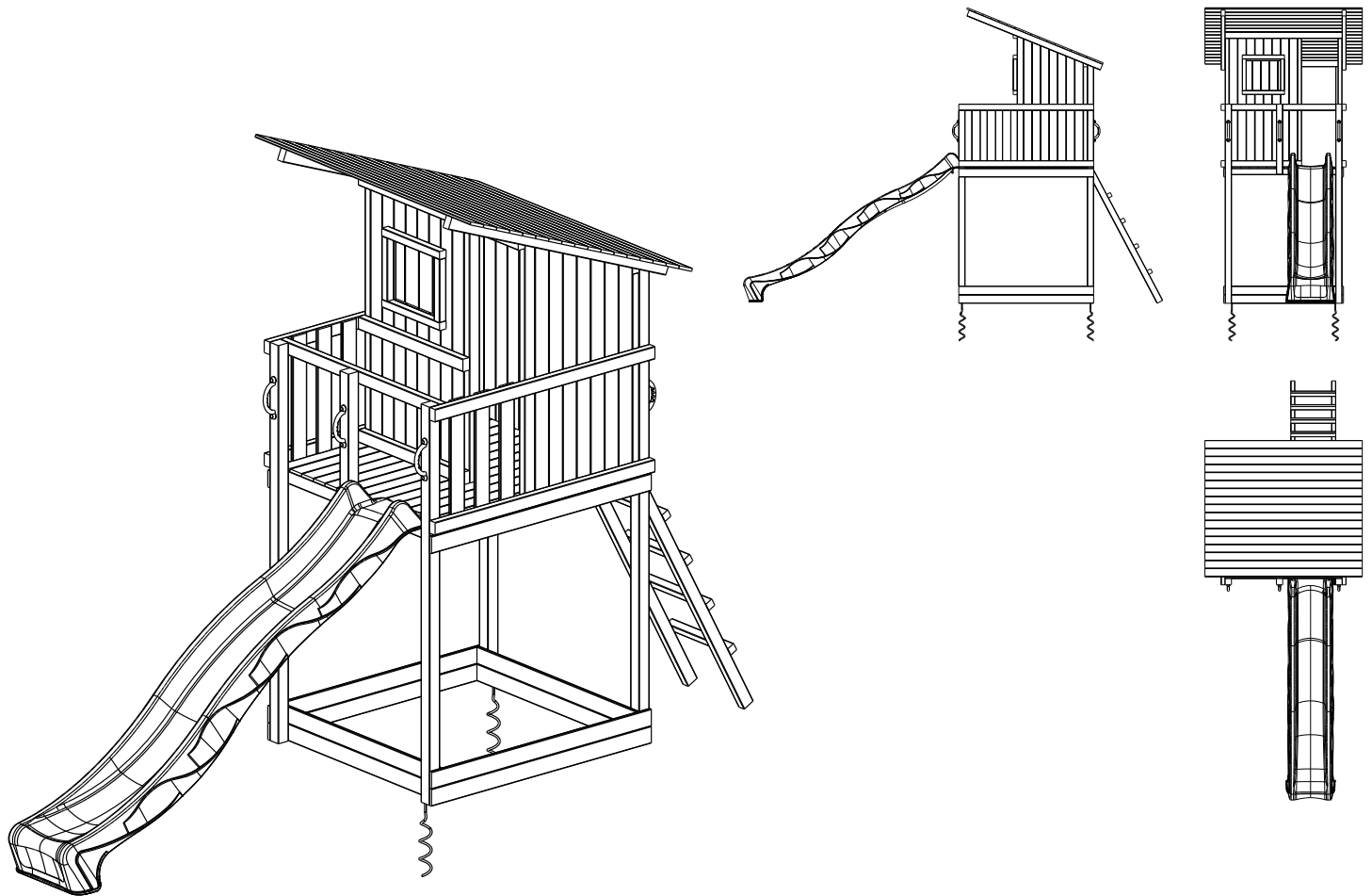

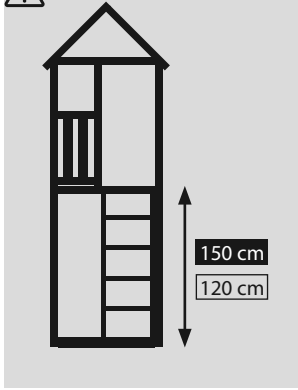
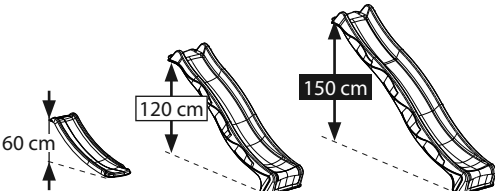

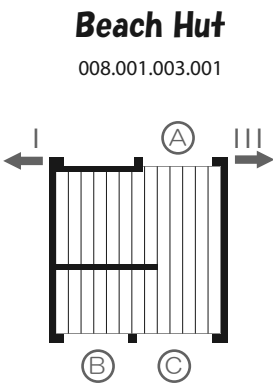

 				<p>@platform 008.003.006.001</p>  	<p>@bridge 008.003.004.001</p> 		
<p>Beach Hut 008.001.003.001</p> 	<p>150 cm</p>	<p>X</p>	<p>X</p>	<p>⊙</p>	<p>I ←</p>	<p>III →</p>	<p>⊙ A ⊙ B</p>
	<p>120 cm</p>	<p>X</p>	<p>⊙</p>	<p>X</p>	<p>I ←</p>	<p>III →</p>	<p>⊙ A ⊙ B</p>

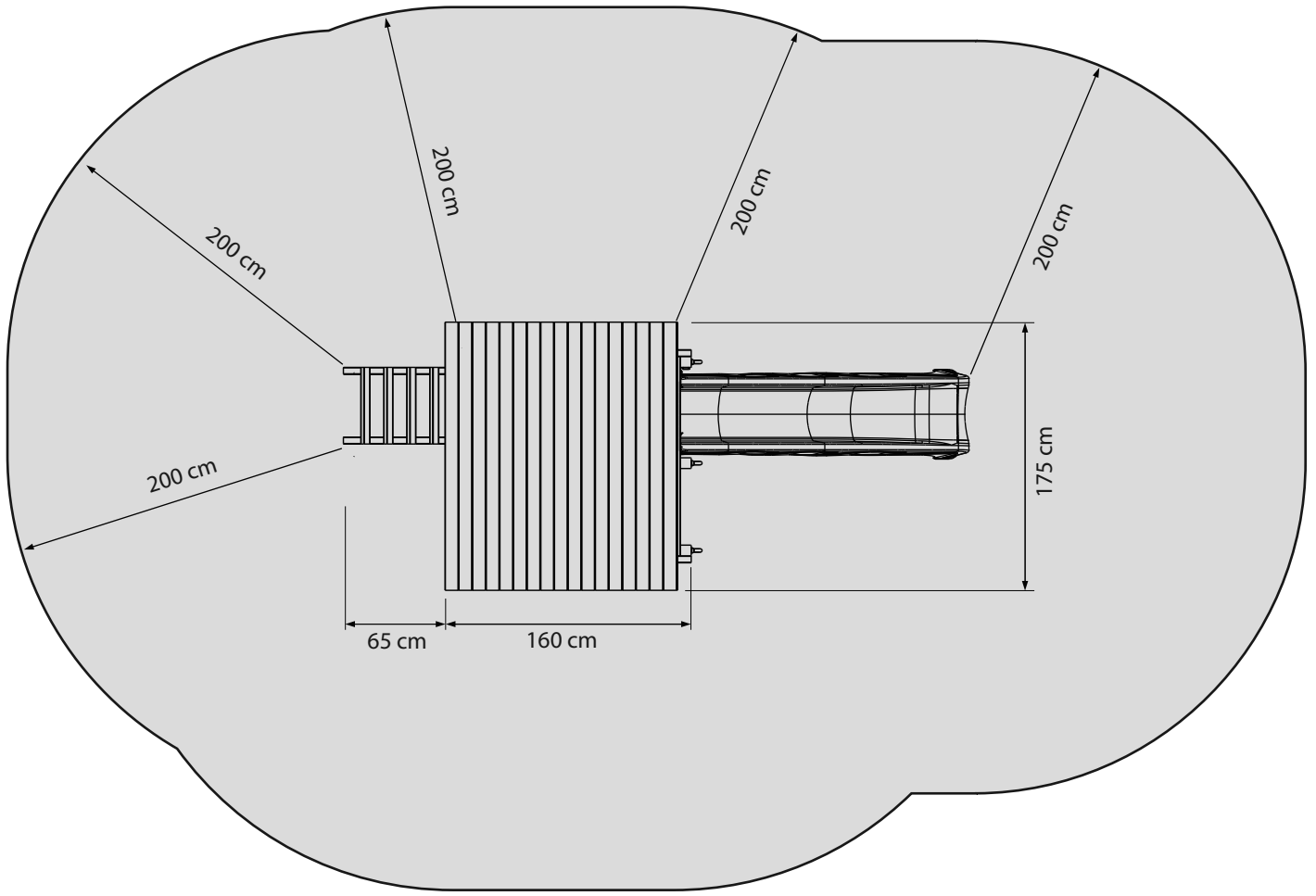

@net 008.003.003.001	@ramp 008.003.002.001	@wall 008.003.001.001	@swing 008.003.005.001	
(A) (B)	(A) (B) X	(A) (B) X	I III ← →	X
(A) (B)	X (A) (B)	X (A) (B)	X	I III ← →

TOOLS REQUIRED

- (1) ratchet spanner with cap 13
- (2) tape measure
- (3) pencil
- (4) bit torx TX20
- (5) bit torx TX30
- (6) bit torx TX40
- (7) drill and/or screwdriver
- (8) square
- (9) wood bore bits \varnothing 3 and \varnothing 5 mm
- (10) speed bore bits \varnothing 10 and \varnothing 28 mm
- (11) wood saw
- (12) hammer
- (13) sandpaper

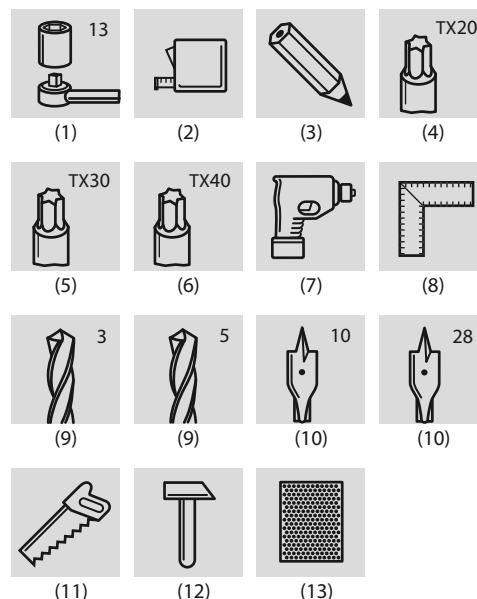

WOOD SCREWS

- step 1/ To prevent the wood splitting we recommend pre-drilling all wood to be screwed. Always drill at least 15 mm less deep than the length of the screw. Pre-drill wood screws with a diameter of 4.5 mm with a 3 mm wood bore bit.
- step 2/ First turn the screw one or two millimetres into the plank to be secured, then press this firmly against the other piece of wood.
- step 3/ Tighten the screw with the torx TX20 bit supplied in the wood until the head of the screw is level with the surface of the wood.

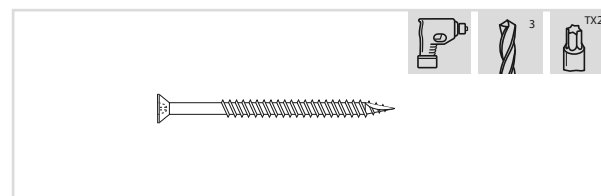

COACH SCREWS

- step 1/ To prevent the wood splitting we recommend pre-drilling all wood to be screwed. Always drill at least 15 mm less deep than the length of the screw. Pre-drill coach screws with a diameter of 8 mm with a 5 mm wood bore bit.
- step 2/ Place the flat washer and the bottom of the protective cap over the shaft of the screw.
- step 3/ First turn the screw one or two millimetres into the beam to be secured, then press this firmly against the other piece of wood.
- step 4/ Tighten the screw with the torx bit TX40 supplied.
- step 5/ Press the top of the protective cap into the opening provided.

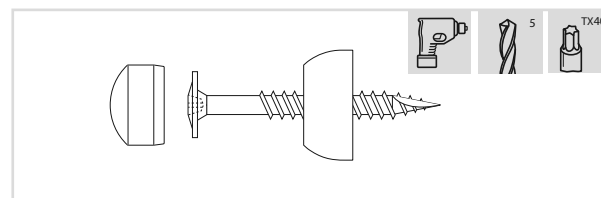

BOLTED CONNECTIONS

- step 1/ Drill a hole with diameter 10 mm through both planks or beams that have already been screwed together (see 'wood screws')
- step 2/ Hit the drive-in nut with a hammer along the designated side of the beam in the hole.
- step 3/ Place the spring ring, the flat washer and then the bottom part of the protective cap over the shaft of the bolt.
- step 4/ Push the bolt through the hole, and turn by hand several times until the bolt turns smoothly in the press-in nut.
- step 5/ Tighten the bolt with torx bit TX40 supplied, until the spring ring is fully flattened between the head of the bolt and the flat washer.
- step 6/ Press the top of the protective cap into the opening provided.

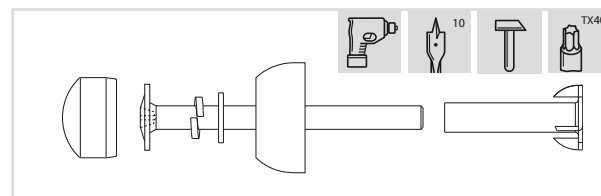

ERFORDERLICHES WERKZEUG

- (1) Universalschraubenschlüssel mit Aufsatz 13
- (2) Maßband
- (3) Bleistift
- (4) Bohrer Torx TX20
- (5) Bohrer Torx TX30
- (6) Bohrer Torx TX40
- (7) Bohr- und/oder Schraubmaschine
- (8) Winkelmass
- (9) Holzbohrer, Durchmesser 3 und 5 mm
- (10) Speedbohrer, Durchmesser 10 und 28 mm
- (11) Holzsäge
- (12) Hammer
- (13) Schleifpapier

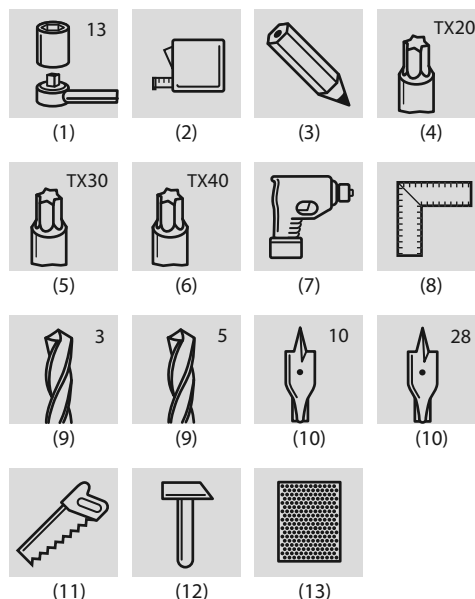

HOLZSCHRAUBEN

Schritt 1/ Um zu vermeiden, dass sich das Holz spaltet, empfehlen wir, alle zu schraubenden Holzteile vorzubohren. Bohren Sie immer mindestens 15 mm weniger tief als die Schraube lang ist. Holzschrauben mit einem Durchmesser von 4,5 mm bohren Sie mit einem Holzbohrer von 3 mm vor.

Schritt 2/ Drehen Sie die Schraube zuerst einige Millimeter in das zu befestigende Brett, und drücken Sie dies danach kräftig gegen das andere Holz.

Schritt 3/ Drehen Sie die Schraube mit dem mitgelieferten Bohrer torx TX20 in das Holz, bis der Kopf der Schraube auf gleicher Höhe mit dem Holz ist.

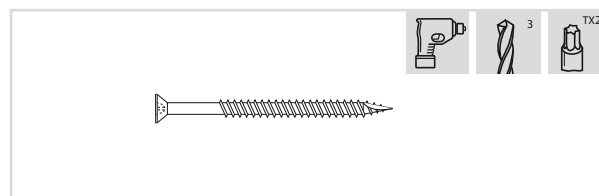

VIERKANT-HOLZSCHRAUBEN

Schritt 1/ Um zu vermeiden, dass sich das Holz spaltet, empfehlen wir, alle zu schraubenden Holzteile vorzubohren. Bohren Sie immer mindestens 15 mm weniger tief, als die Schraube lang ist. Vierkant-Holzschrauben mit einem Durchmesser von 8 mm bohren Sie mit einem Holzbohrer von 5 mm vor.

Schritt 2/ Bringen Sie die Unterlegscheibe und den untersten Teil der Abdeckkappe über dem Schaft der Schraube an.

Schritt 3/ Drehen Sie die Schraube zuerst einige Millimeter in den zu befestigenden Balken, und drücken Sie diesen danach kräftig gegen das andere Holz.

Schritt 4/ Ziehen Sie die Schraube mit der mitgelieferten Bohrer torx TX40 an.

Schritt 5/ Drücken Sie die Kappe der Abdeckkappe in die vorgesehene Öffnung.

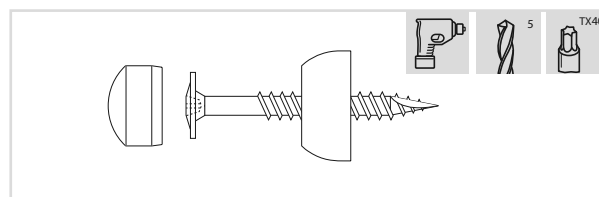

SCHRAUBVERBINDUNGEN

Schritt 1/ Bohren Sie ein Loch mit einem Durchmesser von 10 mm durch beide bereits aneinander geschraubte Bretter oder Balken (siehe 'Holzschrauben').

Schritt 2/ Schlagen Sie die Druckmutter mit einem Hammer entlang der angegebenen Seite des Balkens in das Loch.

Schritt 3/ Bringen Sie den Federring, die Unterlegscheibe und danach den untersten Teil der Abdeckkappe über dem Schaft der Schraube an.

Schritt 4/ Schieben Sie die Schraube durch das Loch, und drehen Sie mit der Hand einige Umdrehungen, bis sich die Schraube zügig in die Druckmutter reht.

Schritt 5/ Ziehen Sie die Schraube mit der mitgelieferten Bohrer torx TX40 an, bis der Federring zwischen dem Kopf der Schraube und der Unterlegscheibe vollständig flachgedrückt ist.

Schritt 6/ Drücken Sie die Kappe der Abdeckkappe in die vorgesehene Öffnung.

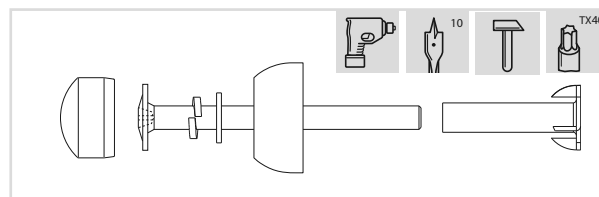

OUTILLAGE NÉCESSAIRE

- (1) clé à cliquet avec douille 13
- (2) mètre roulant
- (3) crayon
- (4) tournevis torx TX20
- (5) tournevis torx TX30
- (6) tournevis torx TX40
- (7) foreuse et / ou visseuse
- (8) équerre
- (9) mèches à bois \varnothing 3 et \varnothing 5 mm
- (10) mèches foret \varnothing 10 et \varnothing 28 mm
- (11) scie à bois
- (12) marteau
- (13) papier émeri

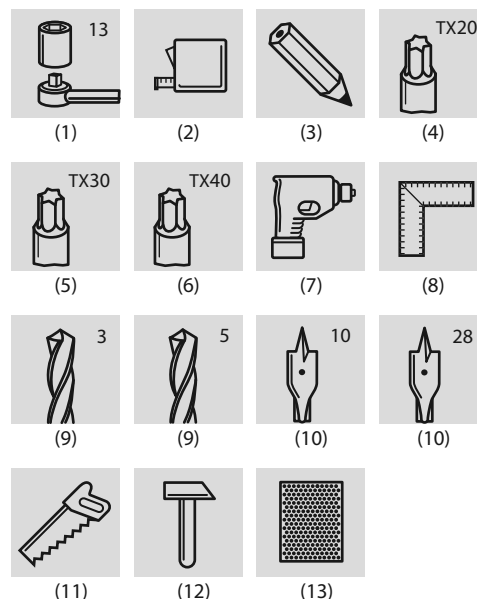

VIS À BOIS

étape 1/ Pour éviter que le bois ne se fende, nous conseillons de forer préalablement tout le bois à visser. La profondeur de forage doit être inférieure d'au moins 15 mm à la longueur de la vis. Les vis à bois de 4,5 mm de diamètre doivent être forés préalablement avec une mèche à bois de 3 mm.

étape 2/ Commencez par tourner la vis de quelques millimètres dans la planche à fixer. Pressez ensuite fermement cette planche contre l'autre bois.

étape 3/ Enfoncez la vis dans le bois avec le tournevis torx TX20 fourni, jusqu'à ce que la tête de la vis soit au même niveau que le bois.

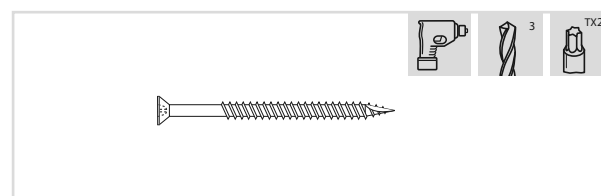

TIRE-FOND

étape 1/ Pour éviter que le bois ne se fende, nous conseillons de forer préalablement tout le bois à visser. La profondeur de forage doit être inférieure d'au moins 15 mm à la longueur de la vis. Les tire-fonds de 8 mm de diamètre doivent être forés préalablement avec une mèche à bois de 5 mm.

étape 2/ Placez la rondelle plate et la partie inférieure du cache-écrou sur la tige de la vis.

étape 3/ Commencez par tourner la vis de quelques millimètres dans la poutre à fixer. Pressez ensuite fermement cette poutre contre l'autre bois.

étape 4/ Enfoncez la vis avec le tournevis torx TX40 fourni.

étape 5/ Enfoncez la petite coiffe du cache-écrou dans l'ouverture prévue.

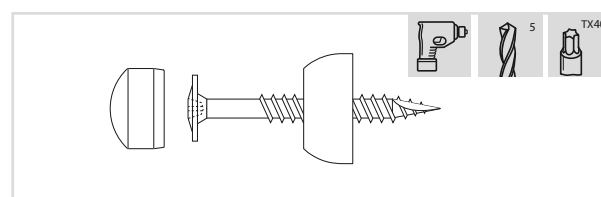

BOULONS

étape 1/ Forez un trou de 10 mm de diamètre à travers les deux planches ou poutres déjà vissées l'une à l'autre (voir « vis à bois »).

étape 2/ Enfoncez l'écrou à presser dans le trou avec un marteau, sur le côté désigné de la poutre.

étape 3/ Placez la bague à ressort, la rondelle plate et, enfin, la partie inférieure du cache-écrou sur la tige du boulon.

étape 4/ Enfoncez le boulon dans l'orifice puis tournez quelques fois manuellement jusqu'à ce que le boulon tourne parfaitement dans l'écrou à presser.

étape 5/ Enfoncez le boulon avec le tournevis torx TX40 fourni, en tournant jusqu'à ce que la bague à ressort soit entièrement enfoncée entre la tête du boulon et la rondelle plate.

étape 6/ Enfoncez la petite coiffe du cache-écrou dans l'ouverture prévue.

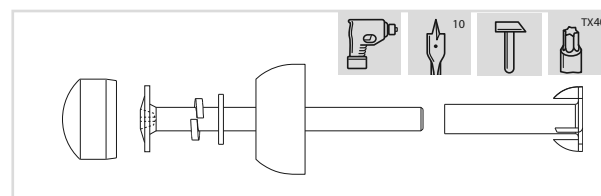

HERRAMIENTAS NECESARIAS

- (1) llave de trinquete con boca del 13
- (2) cinta de medida
- (3) lápiz
- (4) llave torx TX20
- (5) llave torx TX30
- (6) llave torx TX40
- (7) taladro y/o destornillador
- (8) escuadra
- (9) brocas para madera de \varnothing 3 y \varnothing 5 mm
- (10) brocas para taladro de alta velocidad de \varnothing 10 y \varnothing 28 mm
- (11) sierra para madera
- (12) martillo
- (13) papel de lija

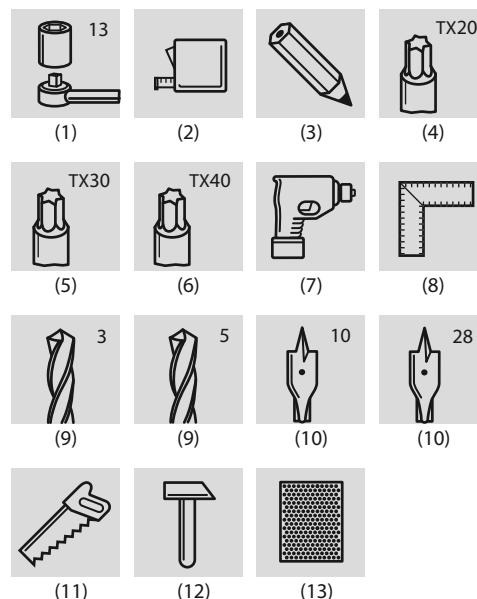

TORNILLOS PARA MADERA

Paso 1/ Para evitar que la madera se abra es recomendable hacer taladros previos en los puntos de inserción de los tornillos. Haga siempre orificios al menos 15 mm menos profundos que la longitud del tornillo. Para los tornillos para madera de 4,5 mm, deben hacerse taladros con una broca para madera de 3 mm.

Paso 2/ Primeramente, inserte el tornillo 1 ó 2 mm en la plancha que desee fijar. A continuación, presione la plancha firmemente contra la otra pieza de madera.

Paso 3/ Apriete el tornillo con la llave torx TX20 que se suministra, hasta que la cabeza del tornillo quede a ras de la madera.

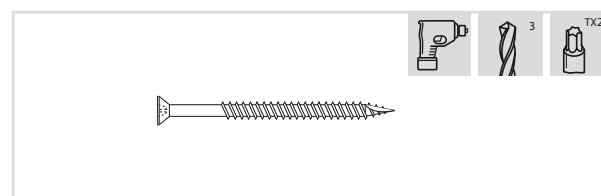

TIRAFONDOS

Paso 1/ Para evitar que la madera se abra es recomendable hacer taladros previos en todos los puntos de inserción de los tornillos. Haga siempre orificios al menos 15 mm menos profundos que la longitud del tornillo. Para los tirafondos de 8 mm, deben hacerse taladros con una broca para madera de 5 mm.

Paso 2/ Inserte la arandela plana y la parte inferior de la cubierta protectora en el filete del tornillo.

Paso 3/ Primeramente, inserte el tornillo 1 ó 2 mm en la viga que desee fijar.

A continuación, presione la viga firmemente contra la otra pieza de madera.

Paso 4/ Apriete el tornillo con ayuda de la llave torx TX40 que se suministra.

Paso 5/ Inserte a presión la parte superior de la cubierta protectora en el orificio previsto para ello.

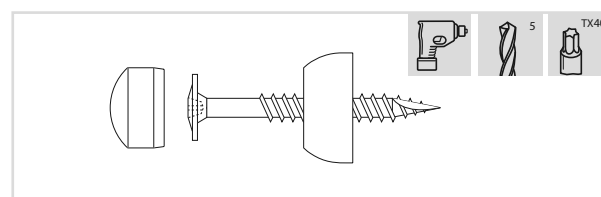

TORNILLOS DE PUNTA PLANA

Paso 1/ Taladre un orificio de 10 mm de diámetro a través de las dos planchas o vigas que ya haya atornillado entre sí (ver "tornillos para madera").

Paso 2/ Inserte la tuerca de seguridad, con ayuda del martillo, por el lado correcto de la viga.

Paso 3/ Inserte la arandela elástica, la arandela plana y, por último, la parte inferior de la cubierta de protección, en el filete del tornillo.

Paso 4/ Pase el tornillo por el orificio y hágalo girar a mano varias veces hasta que entre en la tuerca de seguridad.

Paso 5/ Apriete el tornillo con ayuda de la llave torx TX40 que se suministra, hasta que la arandela flexible quede aplanada por completo entre la cabeza del tornillo y la arandela plana.

Paso 6/ Inserte a presión la parte superior de la cubierta protectora en el orificio previsto para ello.

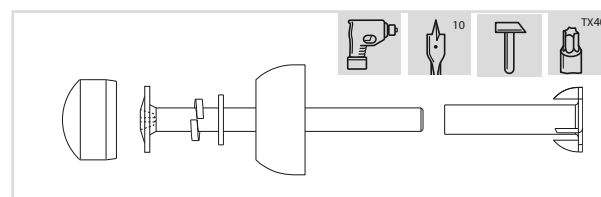

STRUMENTI DA LAVORO NECESSARI

- (1) chiave a cricchetto con attacco da 13
- (2) metro a nastro
- (3) matita
- (4) bit torx TX20
- (5) bit torx TX30
- (6) bit torx TX40
- (7) trapano e/o cacciavite
- (8) squadra
- (9) punte da legno da \varnothing 3 e \varnothing 5 mm
- (10) punte di precisione da \varnothing 10 e \varnothing 28 mm
- (11) sega da legno
- (12) martello
- (13) carta vetrata

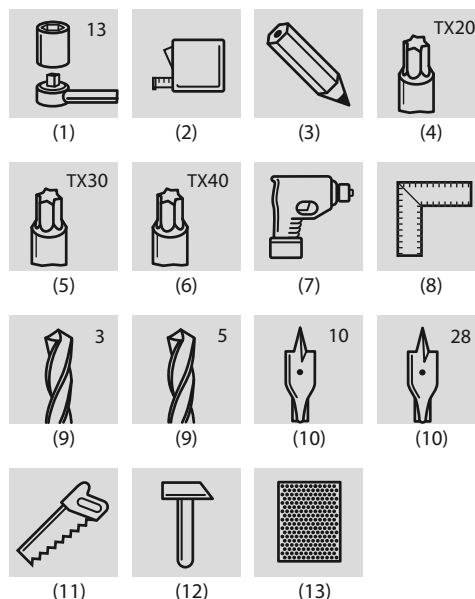

VITI DA LEGNO

- passo 1/ Per prevenire la fessurazione del legno, si raccomanda di effettuare un foro con il trapano prima di inserire le viti. Eseguire un foro profondo almeno 15 mm in meno rispetto alla lunghezza della vite. Per eseguire i fori destinati a viti del diametro di 4,5 mm, utilizzare una punta da legno da 3 mm.
- passo 2/ Inserire la vite uno o due millimetri all'interno dell'asse. Quindi premere l'asse contro l'altra parte di legno a cui dovrà venire agganciata.
- passo 3/ Avvitare la vite con la punta torx TX20 fornita in dotazione fino a quando la testa della vite è perfettamente livellata con la superficie in legno.

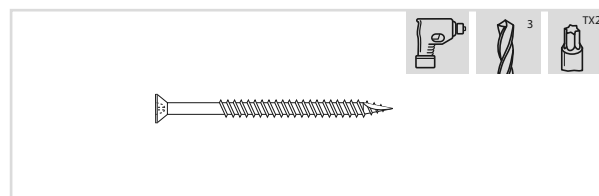

TIRAFONDO

- passo 1/ Per prevenire la fessurazione del legno, si raccomanda di effettuare un foro con il trapano prima di inserire i tirafondi. Eseguire un foro profondo almeno 15 mm in meno rispetto alla lunghezza del tirafondo. Per eseguire i fori destinati a tirafondo del diametro di 8 mm, utilizzare una punta da legno da 5 mm.
- passo 2/ Inserire il corpo del tirafondo nella rondella piana e nella parte inferiore del cappuccio protettivo.
- passo 3/ Inserire il tirafondo uno o due millimetri all'interno dell'asse. Quindi premere l'asse contro l'altra parte in legno a cui dovrà venire agganciata.
- passo 4/ Avvitare il tirafondo con la punta torx TX40 fornita in dotazione.
- passo 5/ Premere la parte superiore del cappuccio protettivo nell'apertura presente sulla testa del tirafondo.

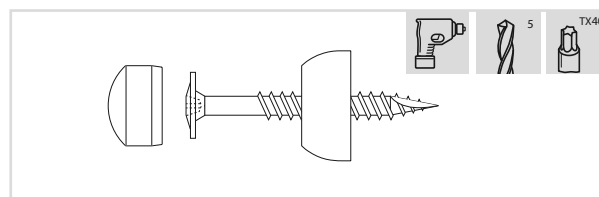

BULLONI

- passo 1/ Eseguire un foro del diametro di 10 mm attraverso le assi già unite mediante le viti (vedere 'Viti da legno').
- passo 2/ Inserire il dado autobloccante nel foro con l'ausilio di un martello nel punto indicato.
- passo 3/ Inserire il corpo del bullone nell'anello elastico, nella rondella piana e nella parte inferiore del cappuccio protettivo.
- passo 4/ Spingere il bullone nel foro e avvitarlo manualmente fino a quando non ruota senza problemi all'interno del dado autobloccante.
- passo 5/ Serrare il bullone con la punta torx TX40 fornita in dotazione, fino a quando l'anello elastico è completamente appiattito fra la testa del bullone e la rondella piana.
- passo 6/ Premere la parte superiore del cappuccio protettivo nell'apertura presente sulla testa del bullone.

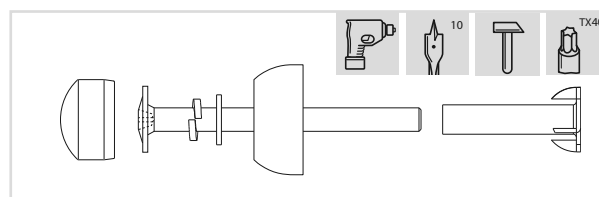

BENODIGD GEREEDSCHAP

- (1) ratelsleutel met dop 13
- (2) rolmeter
- (3) potlood
- (4) bit torx TX20
- (5) bit torx TX30
- (6) bit torx TX40
- (7) boormachine en/of vijsmachine
- (8) winkelhaak
- (9) houtboren \varnothing 3 en \varnothing 5 mm
- (10) speedboren \varnothing 10 en \varnothing 28 mm
- (11) houtzaag
- (12) hamer
- (13) schuurpapier

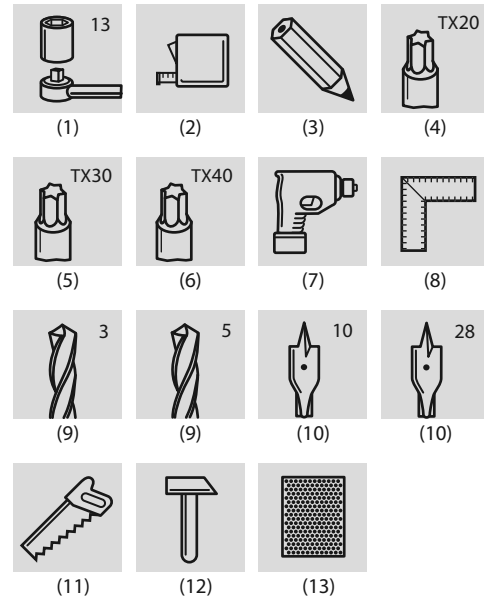

HOUTSCHROEVEN

- stap 1/ Om te vermijden dat het hout splijt raden wij aan alle te schroeven hout voor te boren. Boor steeds minstens 15 mm minder diep dan de schroef lang is. Houtschroeven diameter 4,5 mm boort U voor met een houtboor van 3 mm.
- stap 2/ Draai de schroef eerst enkele millimeter in de te bevestigen plank, en druk deze daarna stevig tegen het andere hout.
- stap 3/ Draai de schroef met bijgeleverde bit torx TX20 in het hout tot de kop van de schroef gelijk komt met het hout.

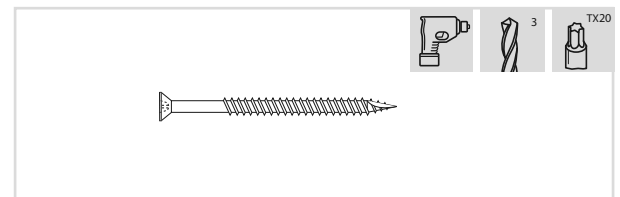

HOUTDRAADBOUTEN

- stap 1/ Om te vermijden dat het hout splijt raden wij aan alle te schroeven hout voor te boren. Boor steeds minstens 15 mm minder diep dan de schroef lang is. Houtdraadbouten diameter 8 mm boort U voor met een houtboor van 5 mm.
- stap 2/ Plaats de vlakke sluitring en het onderste deel van de afdekdop over de schacht van de schroef.
- stap 3/ Draai de schroef eerst enkele millimeter in de te bevestigen balk, en druk deze daarna stevig tegen het andere hout.
- stap 4/ Draai met bijgeleverde torx bit TX40 de schroef aan.
- stap 5/ Druk het kapje van de afdekdop in de voorziene opening.

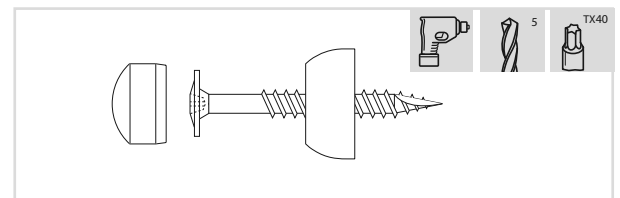

BOUTVERBINDINGEN

- stap 1/ Boor een gat met diameter 10 mm doorheen beide reeds aan elkaar geschroefde planken of balken (zie 'houtschroeven')
- stap 2/ Sla de inslagmoer met een hamer langs de aangeduide zijde van de balk in het gat.
- stap 3/ Plaats de veerring, de vlakke sluitring en vervolgens het onderste deel van de afdekdop over de schacht van de bout.
- stap 4/ Schuif de bout door het gat, en draai met de hand enkele toeren tot de bout vlot in de inslagmoer draait.
- stap 5/ Draai met bijgeleverde torx bit TX40 de bout aan, tot de veerring volledig is platgedrukt tussen de kop van de bout en de vlakke sluitring.
- stap 6/ Druk het kapje van de afdekdop in de voorziene opening.

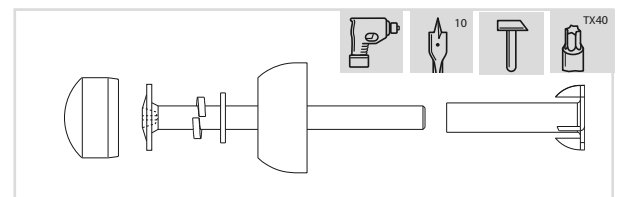

FERRAMENTAS NECESSÁRIAS

- (1) chave de roquete n.º 13
- (2) fita métrica
- (3) lápis
- (4) chave de fendas torx TX20
- (5) chave de fendas torx TX30
- (6) chave de fendas torx TX40
- (7) berbequim para furar e/ou aparafusar
- (8) esquadro
- (9) brocas para madeira de Ø 3 e Ø 5 mm
- (10) brocas de diâmetro Ø 10 e Ø 28 mm
- (11) serra de madeira
- (12) martelo
- (13) papel de lixa

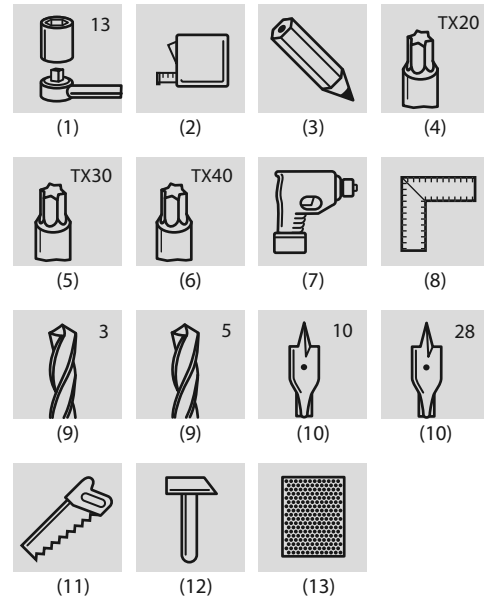

PARAFUSOS PARA MADEIRA

etapa 1/ Para evitar que a madeira se rache, aconselhamos que fure previamente toda a madeira a aparafusar. A profundidade do furo deve ser sempre inferior em, pelo menos, 15 mm ao comprimento do parafuso. Os parafusos para madeira com um diâmetro de 4,5 mm devem ser previamente furados com uma broca para madeira de 3 mm.

etapa 2/ Rode primeiro o parafuso um ou dois milímetros na tábua a fixar, depois carregue com firmeza esta tábua contra a outra madeira.

etapa 3/ Aperte o parafuso com a chave de fendas torx TX20 fornecida, até que a cabeça do parafuso esteja ao mesmo nível que a madeira.

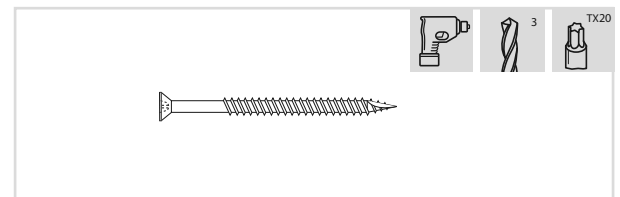

TIRA-FUNDOS

etapa 1/ Para evitar que a madeira se rache, aconselhamos que fure previamente toda a madeira a aparafusar. A profundidade do furo deve ser sempre inferior em, pelo menos, 15 mm ao comprimento do parafuso. Os tirafundos com um diâmetro de 8 mm devem ser previamente furados com uma broca para madeira de 5 mm.

etapa 2/ coloque a anilha chata e a parte inferior da protecção do parafuso na ponta do parafuso.

etapa 3/ Rode primeiro o parafuso um ou dois milímetros na viga a fixar, depois carregue com firmeza esta viga contra a outra madeira.

etapa 4/ Aperte o parafuso com a chave de fendas torx TX40 fornecida.

etapa 5/ Pressione a parte superior da protecção do parafuso no orifício a este fim.

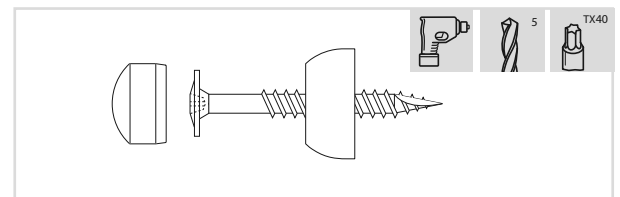

PORCAS

etapa 1/ Faça um furo com 10 mm de diâmetro atravessando as duas tábuas ou vigas já aparafusadas uma na outra (ver 'parafusos para madeira').

etapa 2/ Introduza a porca para empurrar no orifício com um martelo, no lado indicado da viga.

etapa 3/ Coloque a anilha da mola, a anilha chata e a parte inferior da protecção do parafuso na ponta do parafuso.

etapa 4/ Introduza o parafuso no orifício e aparafuse ligeiramente à mão até que o parafuso rode sem dificuldades na porca de premir.

etapa 5/ Aperte o parafuso com a chave de fendas TX40 fornecida, até que a anilha da mola esteja totalmente premida entre a cabeça do parafuso e a anilha chata.

etapa 6/ Pressione a parte superior da protecção do parafuso no orifício a este fim.

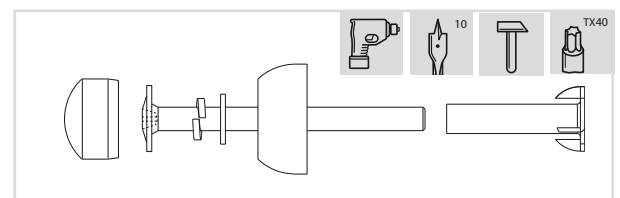

ΑΠΑΙΤΟΥΜΕΝΑ ΕΡΓΑΛΕΙΑ

- (1) κρικωτό κλειδί με κεφαλή 13
- (2) μέτρο (ταινία)
- (3) μολύβι
- (4) άκρο torx TX20
- (5) άκρο torx TX30
- (6) άκρο torx TX40
- (7) τρυπάνι ή/ και κατσαβίδι
- (8) τετράγωνο
- (9) άκρα τρυπανιού ξύλου, διάμετροι 3 και 5 mm
- (10) άκρα τρυπανιού ταχύτητας, διάμετροι 10 και 28 mm
- (11) πριόνι
- (12) σφυρί
- (13) γυαλόχαρτο

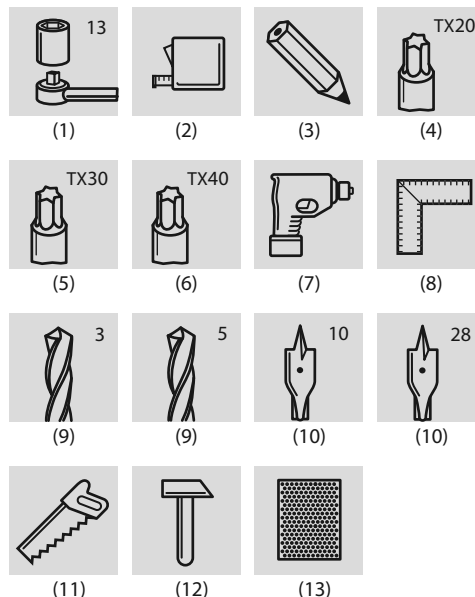

ΞΥΛΟΒΙΔΕΣ

βήμα 1/ Για την αποφυγή ρωγμών στο ξύλο, σας προτείνουμε να τρυπήσετε πρώτα όλα τα ξύλα στα οποία θα μπουν βίδες. Τρυπάτε πάντοτε τουλάχιστον 15 mm λιγότερο από το μήκος της βίδας. Κάντε τις σπές για ξυλόβιδες διαμέτρου 4.5 mm με άκρο τρυπανιού 3 mm.
 βήμα 2/ Στρέψτε πρώτα τις βίδες ένα έως δυο εκατοστά στο ξύλο που θα στερεώσετε, και στη συνέχεια πιέστε το πάνω στο άλλο κομμάτι ξύλου.
 βήμα 3/ Σφίξτε τη βίδα με το άκρο PZ2 που παρέχεται, στο ξύλο, μέχρι το κεφάλι της βίδας να είναι σε ευθεία με την επιφάνεια του ξύλου.

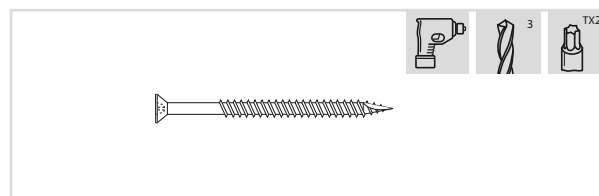

ΞΥΛΟΒΙΔΕΣ COACH

βήμα 1/ Για την αποφυγή ρωγμών στο ξύλο, σας προτείνουμε να τρυπήσετε πρώτα όλα τα ξύλα στα οποία θα μπουν βίδες. Τρυπάτε πάντοτε τουλάχιστον 15 mm λιγότερο από το μήκος της βίδας. Κάντε τις σπές για ξυλόβιδες διαμέτρου 8 mm με άκρο τρυπανιού 5 mm.
 βήμα 2/ Τοποθετήστε τη ροδέλα και το κάτω μέρος του προστατευτικού καπακιού πάνω από τον άξονα της βίδας.
 βήμα 3/ Στρέψτε πρώτα τις βίδες ένα έως δυο εκατοστά στο ξύλο που θα στερεώσετε, και στη συνέχεια πιέστε το πάνω στο άλλο κομμάτι ξύλου.
 βήμα 4/ Σφίξτε τη βίδα με το άκρο TX40 που παρέχεται.
 βήμα 5/ Πιέστε το πάνω μέρος του προστατευτικού καπακιού στο άνοιγμα που υπάρχει.

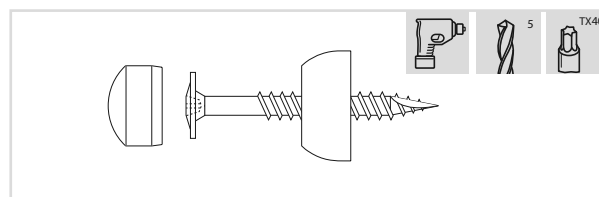

ΣΥΝΔΕΣΕΙΣ ΜΕ ΠΑΞΙΜΑΔΙΑ

βήμα 1/ Κάντε μια οπή διαμέτρου 10 mm και στις δυο σανίδες ή τα δύο ξύλα που έχετε ήδη βιδώσει μαζί (βλ. 'Ξυλόβιδες').
 βήμα 2/ Χτυπήστε το εσωτερικό παξιμάδι με ένα σφυρί για να μπει στην οπή, από την καθορισμένη πλευρά του ξύλου.
 βήμα 3/ Τοποθετήστε το δακτύλιο του ελάσματος, τη ροδέλα και μετά το κάτω μέρος του προστατευτικού καπακιού πάνω από τον άξονα της βίδας.
 βήμα 4/ Πιέστε τη βίδα να περάσει μέσα στην οπή, και στρέψτε τη με το χέρι αρκετές φορές, έως ότου η βίδα να στρέφεται εύκολα μέσα στο εσωτερικό παξιμάδι.
 βήμα 5/ Σφίξτε τη βίδα με το άκρο TX40 που παρέχεται, ούτως ούτως ο δακτύλιος του ελάσματος έχει συμπιεστεί πλήρως μεταξύ της βίδας και της ροδέλας.
 βήμα 6/ Πιέστε το πάνω μέρος του προστατευτικού καπακιού μέχρι να μπει στο άνοιγμα που υπάρχει.

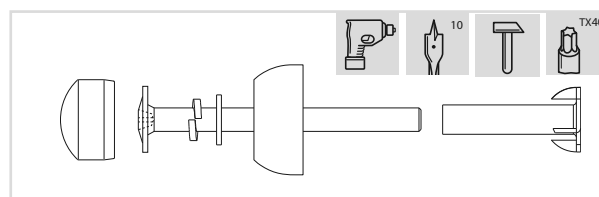

NØDVENDIGT VÆRKTØJ

- (1) skraldenøgle med top str. 13
- (2) målebånd
- (3) blyant
- (4) bit torx TX20
- (5) bit torx TX30
- (6) bit torx TX40
- (7) boremaskine og/eller skruetrækker
- (8) vinkel
- (9) træbor med en diameter på 3 og Ø 5 mm
- (10) metalbor med en diameter på Ø 10 og Ø 28 mm
- (11) træsav
- (12) hammer
- (13) sandpapir

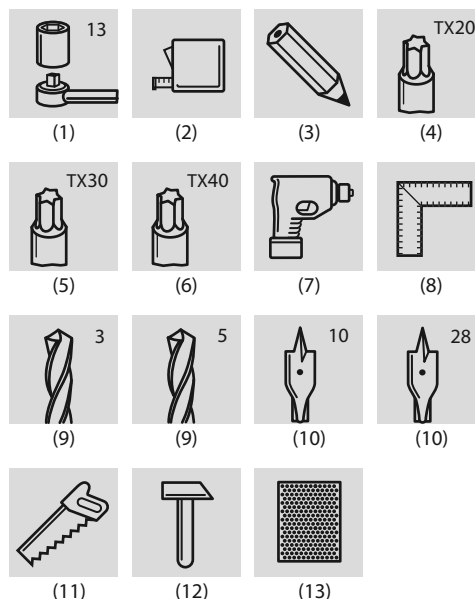

TRÆSKRUER

Trin 1: For at hindre træet i at flække, anbefaler vi, at der bores for i alt træ, der skal skrues i. Bor altid mindst 15 mm kortere end skruens længde. Til træskruer med en diameter på 4,5 mm bores der for med et 3 mm træbor.

Trin 2: Drej først skruen en eller to millimeter ind i den planke, der skal fastgøres, og tryk derefter denne fast imod det andet stykke træ.

Trin 3: Stram derefter skruen i træet med den medfølgende torx TX20-bit, indtil skruens hoved er plant med træets overflade.

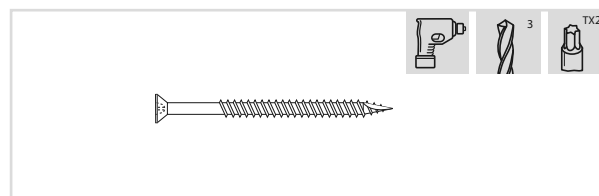

FRANSKE SKRUER

Trin 1: For at forhindre træet i at flække, anbefaler vi, at der bores for i alt træ, der skal skrues i. Bor altid mindst 15 mm kortere end skruens længde. Til franske skruer med en diameter på 8 mm bores der for med et 5 mm træbor.

Trin 2: Anbring den flade skive og bunden af beskyttelseskappen på skruens skaft.

Trin 3: Drej først skruen en eller to millimeter ind i den planke, der skal fastgøres, og tryk derefter denne fast imod det andet stykke træ.

Trin 4: Stram derefter skruen med den medfølgende TX40-bit.

Trin 5: Pres toppen af beskyttelseshætten ind i den dertil beregnede åbning.

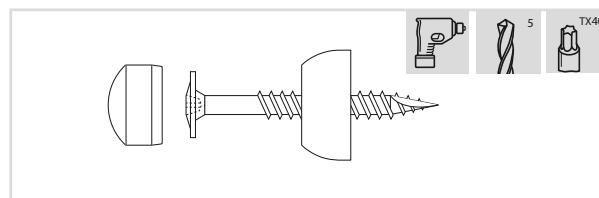

SAMMENBOLTEDE FORBINDELSER

Trin 1: Bor et hul med en diameter på 10 mm gennem begge planker eller bjælker, der allerede er blevet skruet sammen (se 'træskruer')

Trin 2: Med en hammer slås indpresningsmøtrikken ind i hullet på den angivne side af bjælken.

Trin 3: Anbring fjederringen, den flade skive og derefter den nederste del af beskyttelseshætten på boltens skaft.

Trin 4: Skub boltens hoved gennem hullet, og drej den nogle omgange med hånden, indtil den let kan drejes ind i den indpressede møtrik.

Trin 5: Stram boltens hoved med den medfølgende torx TX40-bit, indtil fjederringen er helt flad imellem boltens hoved og den flade spændskive.

Trin 6: Pres toppen af beskyttelseshætten ind i den dertil beregnede åbning.

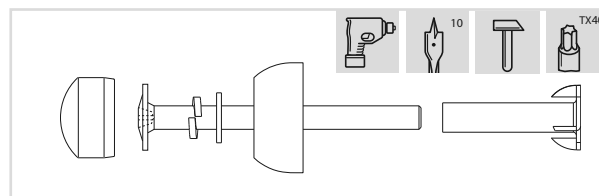

VERKTYG SOM BEHÖVS

- (1) haknyckel med hylsa 13
- (2) måttband
- (3) penna
- (4) skruvmejsel torx TX20
- (5) skruvmejsel torx TX30
- (6) skruvmejsel torx TX40
- (7) borrar och/eller skruvmejsel
- (8) vinkelhake
- (9) träborkronor \varnothing 3 och \varnothing 5 mm
- (10) borkkronor \varnothing 10 och \varnothing 28 mm
- (11) träsåg
- (12) hammare
- (13) sandpapper

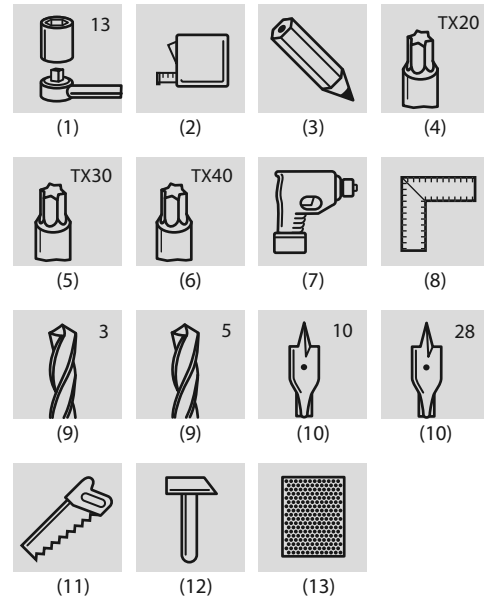

TRÄSKRUVAR

steg 1/ För att förhindra att träet spricker rekommenderar vi att det i förväg borrar hål i träet till skruvarna. Hålet måste alltid vara minst 15 mm kortare än skruvens längd. Borra hål till träskruvar med en diameter av 4,5 mm med en 3 mm träborkrona.

steg 2/ Skruva först skruven en eller två millimeter in i den bräda som skall fästas, tryck sedan denna med ett stadigt grepp mot den andra trädelen.

steg 3/ Dra åt skruven med den medföljande skruvmejseln torx TX20 tills skruvhuvudet är i nivå med träytan.

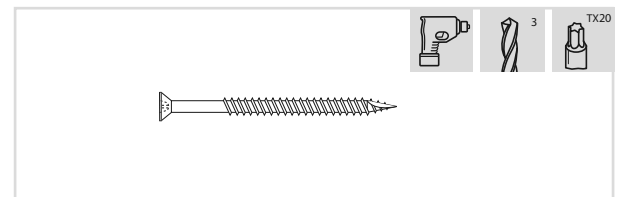

FRANSKA SKRUVAR

steg 1/ För att förhindra att träet spricker rekommenderar vi att det i förväg borrar hål i träet till skruvarna. Hålet måste alltid vara minst 15 mm kortare än skruvens längd. Borra hål till franska skruvar med en diameter av 8 mm med en 5 mm träborkrona.

steg 2/ Placera rundbrickan och pluggen över skruvskafet.

steg 3/ Skruva först skruven en eller två millimeter in i den bjälke som skall fästas, tryck sedan denna med ett stadigt grepp mot den andra trädelen.

steg 4/ Dra åt skruven med den medföljande skruvmejseln torx TX40.

steg 5/ Tryck in pluggen i öppningen.

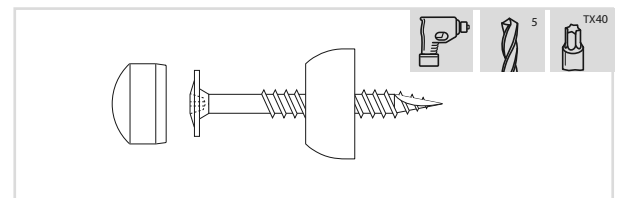

BULTAR

steg 1/ Borra ett hål med en diameter av 10 mm genom båda brädorna eller bjälkarna som redan har skruvats ihop (se 'träskruvar')

steg 2/ Slå in tryckskraven i hålet på den angivna sidan av bjälken med en hammare.

steg 3/ Placera fjäderringen, rundbrickan och pluggen över bultskafet.

steg 4/ Tryck bulten genom hålet och vrid för hand flera gånger tills bulten är väl inskruvad i tryckskraven.

steg 5/ Dra åt bulten med den medföljande skruvmejseln torx TX40 tills fjäderringen ligger platt mellan bulthuvudet och rundbrickan.

steg 6/ Tryck in pluggen i öppningen.

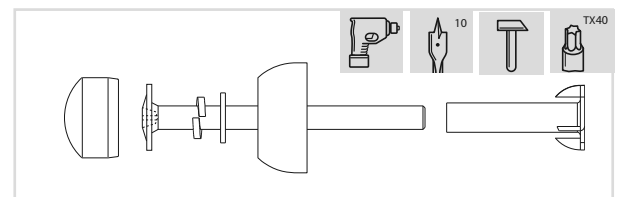

NØDVENDIG VERKTØY

- (1) skrallenøkkel med hylse 13
- (2) målebånd
- (3) blyant
- (4) skrutrekker torx TX20
- (5) skrutrekker torx TX30
- (6) skrutrekker torx TX40
- (7) drill og/eller skrutrekker
- (8) vinkel
- (9) treborkroner \varnothing 3 og \varnothing 5 mm
- (10) borkroner \varnothing 10 og \varnothing 28 mm
- (11) tresag
- (12) hammer
- (13) sandpapir

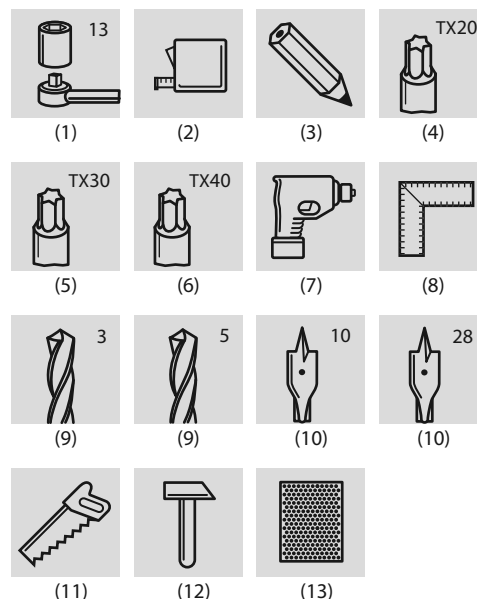

TRESKRUER

trinn 1/ For å unngå at treverket sprekker anbefaler vi at det på forhånd bores hull i treverket til skruene. Hullet må alltid være minst 15 mm kortere enn lengden på skruen. Bor hull til treskruer med en diameter på 4,5 mm med et 3 mm trebor.

trinn 2/ Først skrues skruen en eller to millimeter inn i planken som skal festes, deretter trykkes dette godt mot den andre tredelen.

trinn 3/ Stram til skruen med den medfølgende skrutrekkeren (torx TX20) til skruhodet er i flukt med overflaten.

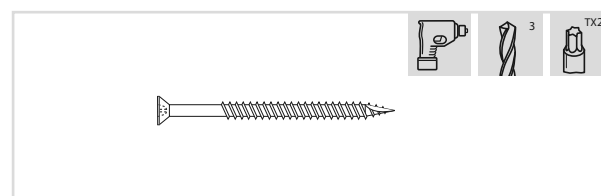

FRANSKE SKRUER

trinn 1/ For å unngå at treverket sprekker anbefaler vi at det på forhånd bores hull i treverket til skruene. Hullet må alltid være minst 15 mm kortere enn lengden på skruen. Bor hull til franske skruer med en diameter på 8 mm med et 5 mm trebor.

trinn 2/ Plasser stoppskiven og pluggen over skrueskafet.

trinn 3/ Først skrues skruen en eller to millimeter inn i bjelken som skal festes, deretter trykkes dette godt mot den andre tredelen.

trinn 4/ Stram til skruen med den medfølgende skrutrekkeren (torx TX40).

trinn 5/ Trykk inn pluggen i åpningen.

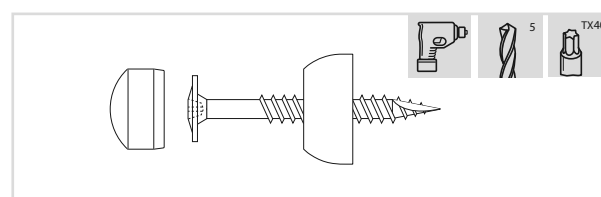

BOLTER

trinn 1/ Bor et hull med en diameter på 10 mm gjennom begge plankene eller bjelkene som allerede er skrudd sammen (se 'treskruer').

trinn 2/ Slå trykkmutteren inn i hullet (på den angitte siden av bjelken) med en hammer.

trinn 3/ Plasser fjærringen, stoppskiven og pluggen over bolteskaftet.

trinn 4/ Trykk bolten gjennom hullet og vri for hånd flere ganger til bolten skrues godt inn i trykkmutteren.

trinn 5/ Stram til bolten med den medfølgende skrutrekkeren (TX40) til fjærringen ligger flatt mellom boltehodet og stoppskiven.

trinn 6/ Trykk inn pluggen i åpningen.

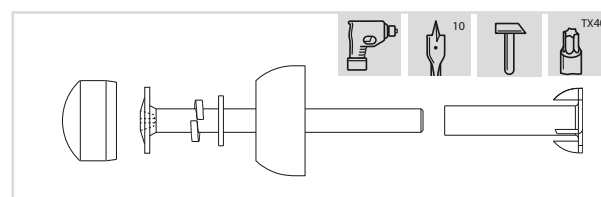

TARVITTAVAT TYÖKALUT

- (1) räikkävain hylsillä 13
- (2) mittanauha
- (3) kynä
- (4) kärki torx TX20
- (5) kärki torx TX30
- (6) kärki torx TX40
- (7) pora ja/tai ruuvimeisseli
- (8) suorakulma
- (9) 3 ja 5 mm puuporanterät
- (10) 10 ja 28 mm poranterät
- (11) puusaha
- (12) vasara
- (13) hiekkapaperia

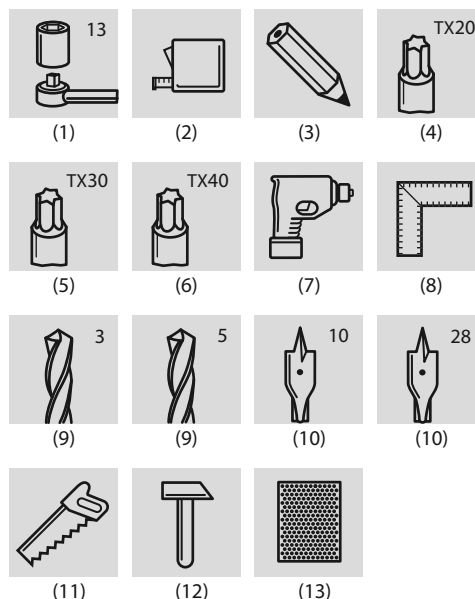

PUURUUVIT

Vaihe 1/ Puun halkeamisen estämiseksi suosittelemme kaikkien puiden ruuvauskohteiden esiporausta. Pora reikä aina vähintään 15 mm matalammaksi kuin ruuvien pituus. Esiporaa 4,5 mm:n ruuvien reiät 3 mm:n terällä.

Vaihe 2/ Kierrä ruuvia ensin 1 - 2 mm kiinnitettävään lankkuun tai lautaan, paina se sitten tukevasti vasten toista puukappaletta.

Vaihe 3/ Kierrä ruuvi puuhun toimitukseen kuuluvalla torx TX20 kärjellä kunnes ruuvin kanta on tasan puun pinnan kanssa.

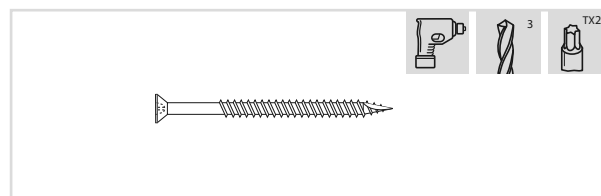

KANSIRUUVIT

Vaihe 1/ Puun halkeamisen estämiseksi suosittelemme kaikkien puiden ruuvauskohteiden esiporausta. Pora reikä aina vähintään 15 mm matalammaksi kuin ruuvien pituus. Esiporaa 8 mm:n ruuvien reiät 5 mm:n terällä.

Vaihe 2/ Laita aluslevy ja suojakannen alaosa ruuvien varren yli.

Vaihe 3/ Kierrä ruuvia ensin 1 - 2 mm kiinnitettävään palkkiin, paina se sitten tukevasti vasten toista puukappaletta.

Vaihe 4/ Kiristä ruuvi toimitukseen kuuluvalla torx TX40.

Vaihe 5/ Paina suojakannen päällyspuoli olemassa olevaan aukkoon.

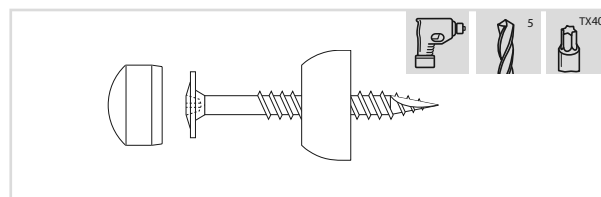

PULTATUT LIITOKSET

Vaihe 1/ Pora 10 mm:n reikä molempien lankkujen/lautojen tai palkkien läpi, jotka on jo aiemmin ruuvattu yhteen (katso "puuruuvit").

Vaihe 2/ Lyö sisään painettava mutteri vasaralla reikään, joka on palkin ko. puolella.

Vaihe 3/ Työnnä jousirengas, aluslevy ja sitten suojakannen alaosa pultin varren yli.

Vaihe 4/ Paina pultti reiän läpi ja kierrä sitä useita kertoja kunnes se kiertyy pehmeästi sisään painettavassa mutterissa.

Vaihe 5/ Kiristä pultti toimitukseen kuuluvalla torx TX40, kunnes jousi on täysin puristunut pultin kannan ja aluslevyn välissä.

Vaihe 6/ Paina suojakannen päällyspuoli olemassa olevaan aukkoon.

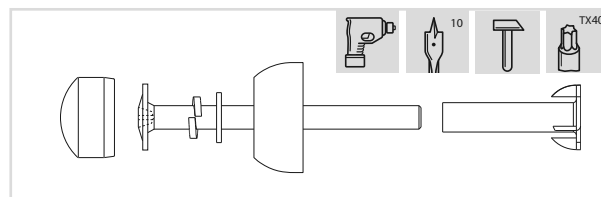

WYMAGANE NARZĘDZIA

- (1) klucz nasadowy 13 z grzechotką
- (2) miarka
- (3) ołówek
- (4) bit torx TX20
- (5) bit torx TX30
- (6) bit torx TX40
- (7) wiertarka / lub wkrętarka
- (8) ekierka
- (9) wiertło do drewna $\varnothing 3$ i $\varnothing 5$ mm
- (10) wiertło piórkowe $\varnothing 10$ i $\varnothing 28$ mm
- (11) piła do drewna
- (12) młotek
- (13) papier ścierny

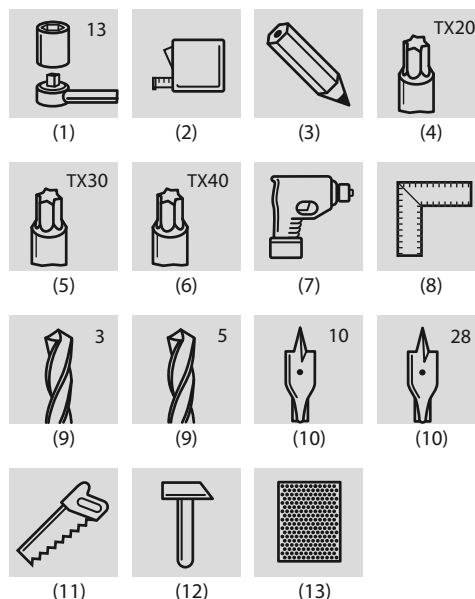

WKRĘTY DO DREWNA

- krok 1/ Aby zapobiec rozłupywaniu się elementów drewnianych, zalecamy wykonanie wstępnych wierceń we wszystkich elementach drewnianych łączonych wkrętami. Należy wiercić zawsze co najmniej 15 mm płycej niż długość wkręta.
- Nawiert pod wkręty o średnicy 4,5 mm należy wykonać wiertłem o średnicy 3 mm.
- krok 2/ Wkręć wkręt jeden lub dwa milimetry w głąb deski, tak przygotowany element przyłóż do kolejnego elementu i skręć je razem.
- krok 3/ Należy wkręcić wkręt używając bit torx TX20 tak, aby główka wkrętu nie wystawała ponad powierzchnię drewna.

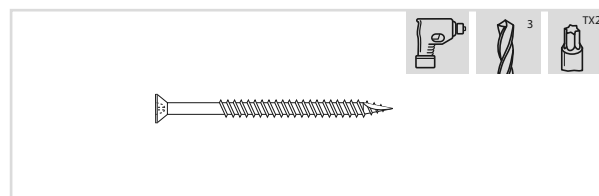

ŁĄCZENIE WKRĘTEM

- krok 1/ Aby zapobiec rozłupywaniu się elementów drewnianych, zalecne jest wykonanie wstępnych wierceń w elementach drewnianych, które będą skręcane. Należy wiercić zawsze o 15 mm płycej niż długość wkręta. Wykonać wiercenie pod wkręty o średnicy 8 mm wiertłem 5-mm.
- krok 2/ W dolną część plastikowej maskownicy należy włożyć wkręt.
- krok 3/ Najpierw należy wkręcić wkręt jeden lub dwa milimetry w głąb deski, tak przygotowany element przyłóż do kolejnego elementu i skręć je razem.
- krok 4/ Należy wkręcić wkręt używając bity torx TX40.
- krok 5/ Należy wcisnąć górną część maskownicy w otwór.

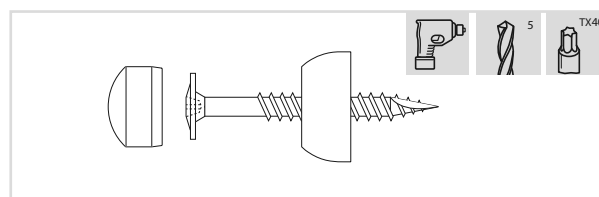

ŁĄCZENIE ŚRUBĄ

- krok 1/ Wykonać otwór o średnicy 10 mm w obu deskach lub belkach, które zostały już połączone wkrętami (patrz "wkręty do drewna")
- krok 2/ Wbić młotkiem nakrętkę kłową gwintowaną odpowiednią stroną w otwór.
- krok 3/ Na śrubę włożyć podkładkę samokontrującą, podkładkę płaską a następnie dolną część maskownicy.
- krok 4/ Należy popchać śrubę przez otwór i kręcić do chwili, kiedy śruba zacznie się wkręcać w nakrętkę kłową.
- krok 5/ Dokręcić śrubę za pomocą bit torx TX40 tak, tak, aby łeb śruby był całkowicie schowany.
- krok 6/ Nałożyć górną część maskownicy.

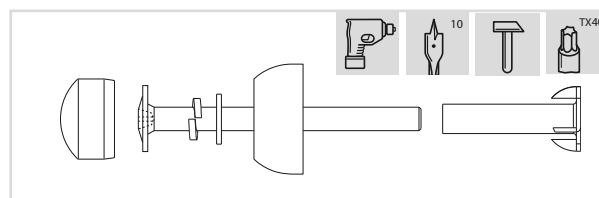

POTŘEBNÉ NÁŘADÍ

- (1) ráčnový klíč 13 mm
- (2) svinovací metr
- (3) tužka
- (4) bit torx TX20
- (5) bit torx TX30
- (6) bit torx TX40
- (7) vrtačka a/nebo šroubovák
- (8) úhelník
- (9) vrták do dřeva Ø 3 a 5 mm
- (10) plochý vrták do dřeva Ø 10 a Ø 28 mm
- (11) pila
- (12) kladivo
- (13) brusný papír

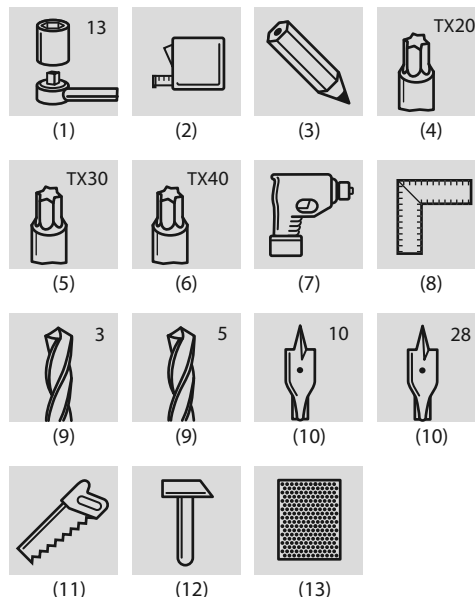

VRUTY

1. krok/ Aby se zabránilo rozštěpování dřevěných prvků, doporučujeme provedení přípravného vrtání ve všech dřevěných prvcích spojovaných vruty. Vrt vždy musí být nejméně o 15 mm mělčí než je délka vrutu.
- Otvor pro vruty o průměru 4,5 mm se provádí vrtákem o průměru 3 mm.
2. krok/ Našroubujte vrut jeden nebo dva milimetry do prkna, takto připravený prvek přiložte k dalšímu prvku a sešroubujte je dohromady.
3. krok/ Vrut dotáhněte pomocí bit torx TX20 tak, aby hlavička vrutu nevyčnívala nad povrch dřeva.

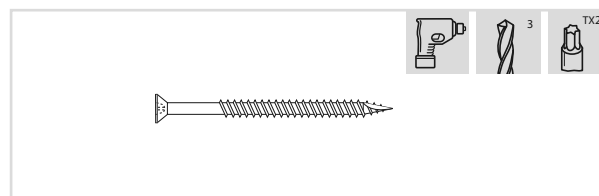

SPOJOVÁNÍ VRUTEM

1. krok/ Aby se zabránilo rozštěpování dřevěných prvků, doporučujeme provedení přípravného vrtání ve všech dřevěných prvcích spojovaných vruty. Vrt vždy musí být nejméně o 15 mm mělčí než je délka vrutu. Otvor pro vruty o průměru 8 mm se provádí vrtákem o průměru 5 mm.
2. krok/ Do spodní části plastového krytu vložte vrut.
3. krok/ Nejprve našroubujte vrut jeden nebo dva milimetry do prkna, takto připravený prvek přiložte k dalšímu prvku a sešroubujte je dohromady.
4. krok/ Vrut dotáhněte pomocí bit torx TX40.
5. krok/ Vrchní část ochranné krytky zatlačte do otvoru.

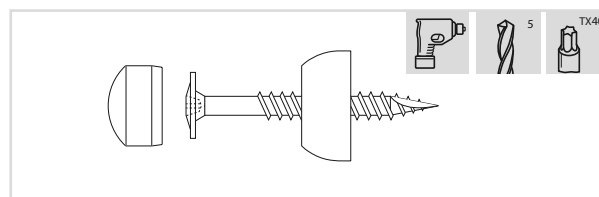

ŠROUBOVÉ SPOJE

1. krok/ Vyvrtejte otvor o průměru 10 mm skrz obě prkna nebo nosíky, které již byly spojeny vruty. (viz. „vruty“).
2. krok/ Zatlučte kladivem narážecí matici správnou stranou do otvoru.
3. krok/ Na šroub nasadte pružící podložku, plochou podložku a pak spodní část krytky.
4. krok/ Protlačte šroub přes otvor a ručně jím otáčejte, až se šroub začne zašroubovávat do narážecí matice.
5. krok/ Dotáhněte šroub pomocí bit torx TX40 tak, aby hlava šroubu byla zcela ukrytá.
6. krok/ Nasadte vrchní část krytky.

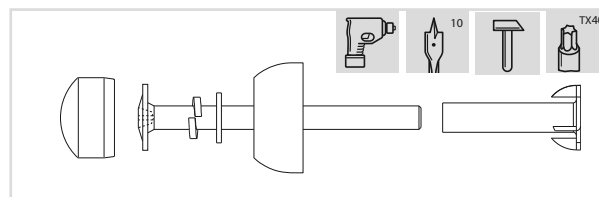

POTREBNÉ NÁRADIE

- (1) račňový kľúč 13 mm
- (2) zvinovací meter
- (3) ceruzka
- (4) bit Torx TX20
- (5) bit Torx TX30
- (6) bit Torx TX40
- (7) vŕtačka alebo skrutkovač
- (8) uholník
- (9) vrták do dreva Ø 3 a 5 mm
- (10) plochý vrták do dreva Ø 10 a Ø 28 mm
- (11) píla
- (12) kladivo
- (13) brúsny papier

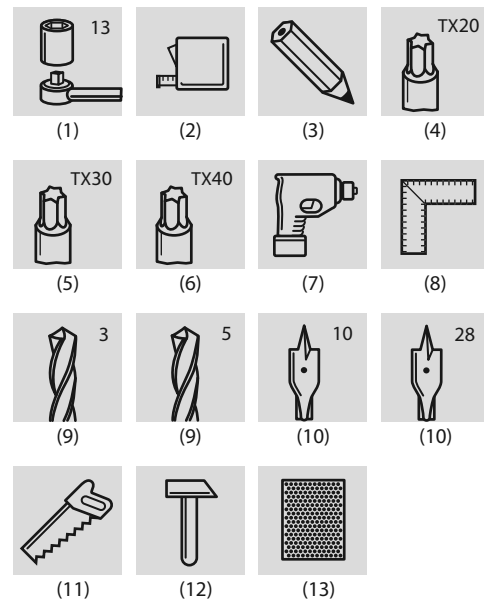

SKRUTKY DO DREVA

krok 1/ Za účelom predchádzania rozštípeniu sa drevených častí odporúčame vykonanie úvodných vrtov vo všetkých drevených dieloch spojených skrutkami do dreva. Treba vŕtať vždy najmenej 15 mm plytšie od dĺžky vrtáka.

Navŕtanie pre skrutky do dreva s priemerom 4,5 mm je treba vykonať vrtákom s priemerom 3 mm.

krok 2/ Zaskrutkujte jednu skrutku do dreva jeden alebo milimetre do dosky, takto pripevnený diel priložte k ďalšiemu dielu a spojte ich spolu.

krok 3/ Zaskrutkujte skrutku do dreva s použitím bitu torx TX20 tak, aby hlavička skrutky do dreva nevyčnievala na plochu dreva.

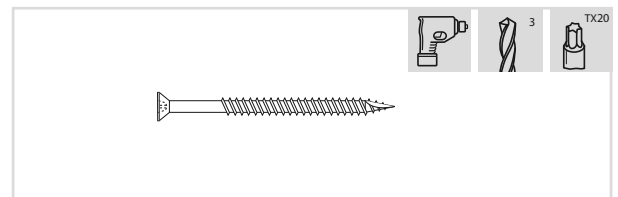

SPÁJANIE SKRUTKAMI

krok 1/ Za účelom predchádzania rozštípeniu sa drevených častí odporúčame vykonanie úvodných vrtov vo všetkých drevených dieloch spojených skrutkami do dreva. Treba vŕtať vždy najmenej 15 mm plytšie od dĺžky vrtáka. Navŕtanie pre skrutky do dreva s priemerom 8 mm je treba vykonať vrtákom s priemerom 5-mm.

krok 2/ Do spodnej časti plastového maskovacieho rámu je treba vložiť skrutku do dreva krytu.

krok 3/ Zaskrutkujte jednu skrutku do dreva jeden alebo milimetre do dosky, takto pripevnený diel priložte k ďalšiemu dielu a spojte ich spolu.

krok 4/ Zaskrutkujte skrutku do dreva s použitím bitu torx TX40.

krok 5/ Hornú časť maskovacieho rámu je treba zatlačiť do otvoru.

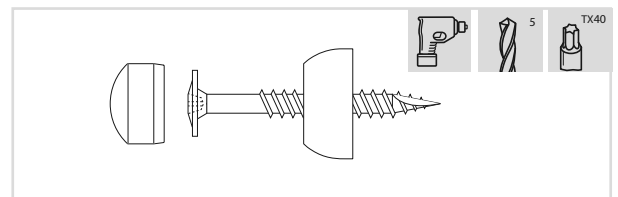

SKRUTKOVÉ SPOJE

krok 1/ Urobte otvor s priemerom 10 mm v oboch doskách alebo nosníkoch, ktoré sú už spojené skrutkami do dreva (viď "skrutky do dreva").

krok 2/ Kladivom vrazte hrotovú maticu so závitom na príslušnú stranu do otvoru.

krok 3/ Na skrutku nasadte podložku s vlastným odporom, plochú podložku a následne spodnú časť maskovacieho rámu.

krok 4/ Skrutku je treba pretlačiť cez otvor a doťahovať až kým sa skrutka nezačne zatáčať do hrotovej matice.

krok 5/ Skrutku dotiahnite pomocou bitu torx TX40 tak, aby hlavička skrutky bola úplne schovaná.

krok 6/ Nasadte hornú časť maskovacieho rámu.

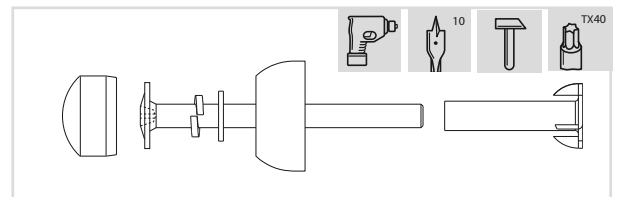

POTREBNO ORODJE

- (1) nasadni ključ 13 in pribor
- (2) merilni trak
- (3) svinčnik
- (4) nastavek torx TX20
- (5) nastavek torx TX30
- (6) nastavek torx TX40
- (7) vrtni stroj / ali vijaknik
- (8) sekira
- (9) sveder za les ϕ 3 in ϕ 5 mm
- (10) ploščati rezkalni sveder ϕ 10 i ϕ 28 mm
- (11) žaga za les
- (12) kladivo
- (13) brusilni papir

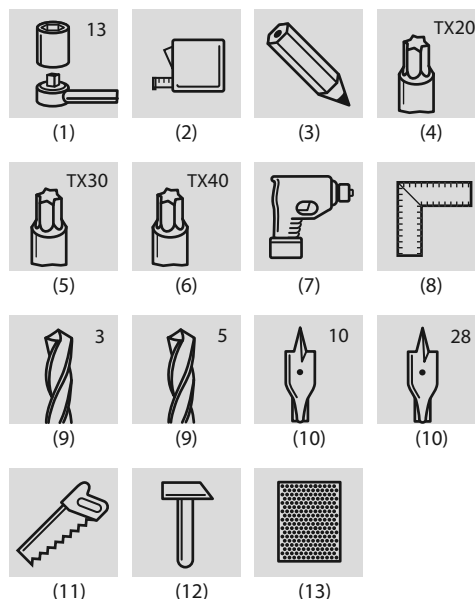

VIJAKI ZA LES

Korak 1/ Da bi preprečili cepljenje lesa, priporočamo predhodno vrtnje v vse lesene elemente, ki so spojene z vijaki. Luknje je treba vedno vrtati vsaj 15 mm plitveje od dolžine vijaka.

Luknjo za vijak s premerom 4,5 mm naredite s svedrom s premerom 3 mm.

Korak 2/ Najprej je treba priviti vijak 1 ali 2 mm v desko, tako pripravljeni element položiti na drugi element in ju priviti skupaj.

Korak 3/ Treba je priviti vijak s pomočjo torxa TX20 tako, da ne bi glava vijaka štrllila nad površino lesa.

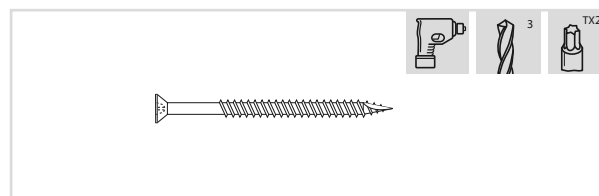

SPOJITEV Z VIJAKI ZA LES

Korak 1/ Da bi preprečili cepljenje lesa, priporočamo predhodno vrtnje v lesene elemente, ki jih nato spojite. Treba je vedno vrtati 15 mm plitveje kot dolžina vijaka. Za vijake s premerom ϕ 8 mm je treba opraviti vrtnje s svedrom 5 mm.

Korak 2/ V spodnji del plastične kape je treba namestiti vijak.

Korak 3/ Najprej je treba priviti vijak 1 ali 2 mm v desko, tako pripravljeni element položiti na drugi element in ju priviti skupaj.

Korak 4/ Treba je priviti vijak s pomočjo torxa TX40.

Korak 5/ Zgornji del plastične kape je treba potisniti v luknjo.

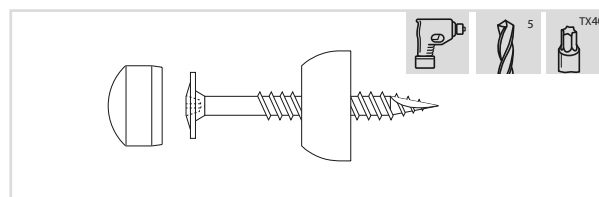

SPOJITEV Z VIJAKI

Korak 1/ Naredite luknjo s premerom 10 mm v obeh deskah ali drogovih, ki sta bila že spojena z vijaki za les (glejte »Spojitev z vijaki za les«).

Korak 2/ Zabijte s kladivom navojno matico v pravo smer v luknjo.

Korak 3/ Na vijak namestite samovarovalno podložko, ploščato podložko, nato pa spodnji del kape.

Korak 4/ Treba je potisniti vijak skozi luknjo in ga obračati, dokler se ne začne privijati v matico.

Korak 5/ Dobro privijte vijak s pomočjo torxa TX40 tako, da bi se vijak popolnoma skrnil.

Korak 6/ Namestite zgornji del kape.

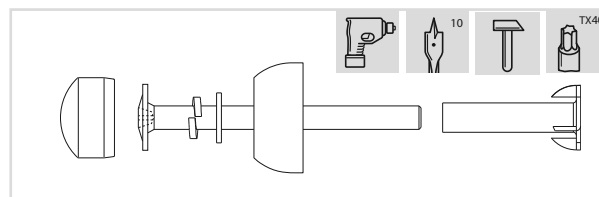

POTREBNI ALATI

- (1) nasadni ključ 13
- (2) mjerna traka
- (3) olovka
- (4) bit torx TX20
- (5) bit torx TX30
- (6) bit torx TX40
- (7) bušilica i/ili odvijač
- (8) crtački trokut
- (9) svrdlo za drvo $\varnothing 3$ i $\varnothing 5$ mm
- (10) plosnato svrdlo $\varnothing 10$ i $\varnothing 28$ mm
- (11) pila za drvo
- (12) čekić
- (13) brusni papir

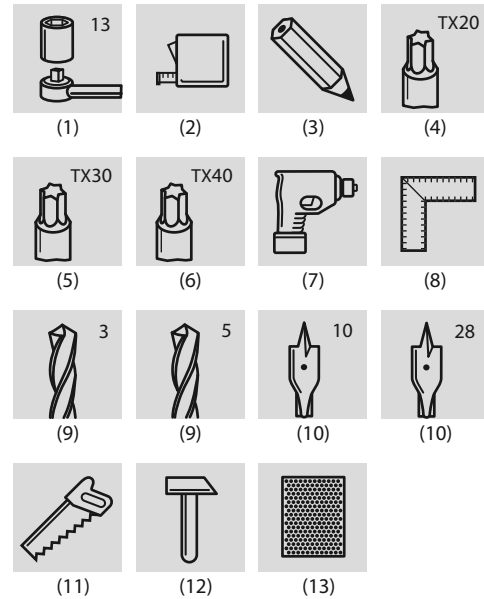

VIJCI ZA DRVO

1. korak/ Da bi se izbjeglo pucanje drvenih elemenata, preporučujemo izbušiti rupe u svim elementima koje se spajaju vijcima. Treba bušiti barem 15 mm pliće nego što je dužina vijka.

Bušenje za vijke s promjerom od 4,5 mm treba napraviti svrdlom s promjerom 3mm.

2. korak/ Zategnite vijak jedan ili dva milimetra u dasku, tako pripremljen element sastavite s drugim elementom i spojite ih zajedno.

3. korak/ Treba zatezati vijak uz pomoć bita torx TX20 tako da glava vijka ne strši iznad razine drva.

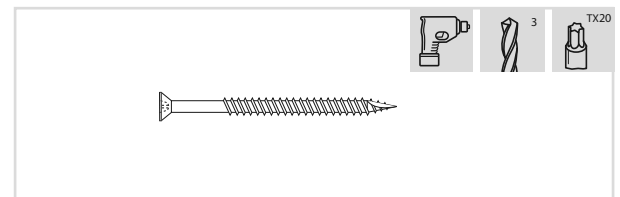

SPAJANJE VIJKOM

1. korak/ Da bi se izbjeglo pucanje drvenih elemenata, preporučujemo izbušiti rupe u svim elementima koje se spajaju vijcima. Treba bušiti uvijek barem 15 mm pliće nego što je dužina vijka. Bušenje za vijke s promjerom od 8 mm napravi svrdlom s promjerom 5mm.

2. korak/ U donji dio plastičnog poklopca treba staviti vijak.

3. korak/ Prvo zategnite vijak jedan ili dva milimetara u dasku, tako pripremljen element sastavite s drugim elementom te ih spojite zajedno.

4. korak/ Treba zatezati vijak uz pomoć bita torx TX40.

5. korak/ Stavite gornji dio poklopca u otvor.

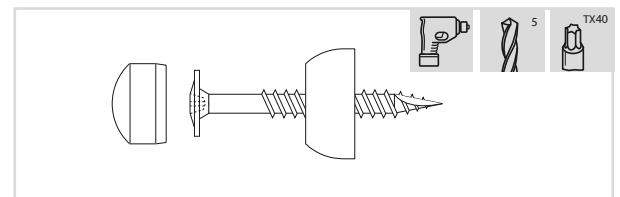

SPAJANJE MATIČNIM VIJKOM

1. korak/ Izbušiti rupu promjera 10 mm u dvije daske ili grede, koje su već spojene vijcima (pogledajte "vijci za drvo")

2. korak/ Uz pomoć čekića stavite maticu s navojem određenom stranom u otvor.

3. korak/ Na maticu staviti zupčastu podlošku a zatim donji dio poklopca.

4. korak/ Treba gurnuti vijak i zatezati ga sve dok vijak neće se zatezati u maticu.

5. korak/ Zategnite vijak uz pomoć bita torx TX40 tako, da glava vijka je kompletno skrivena.

6. korak/ Stavite gornji dio poklopca.

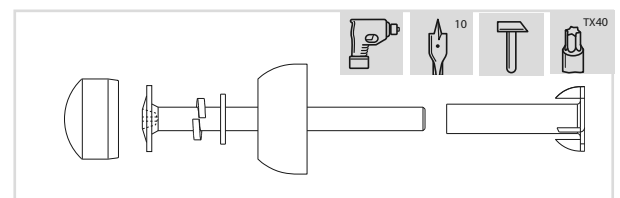

SZÜKSÉGES SZERSZÁMOK

- (1) 13 mm villáskulcs
- (2) lapát
- (3) ceruza
- (4) bit torx TX20
- (5) bit torx TX30
- (6) bit torx TX40
- (7) fúró / vagy kézi fúró
- (8) derékszög
- (9) 3 és 5 mm átmérőjű fáfúró
- (10) 10 és 28 mm átmérőjű fáfúró
- (11) fűrész
- (12) kalapács
- (13) csiszolópapír

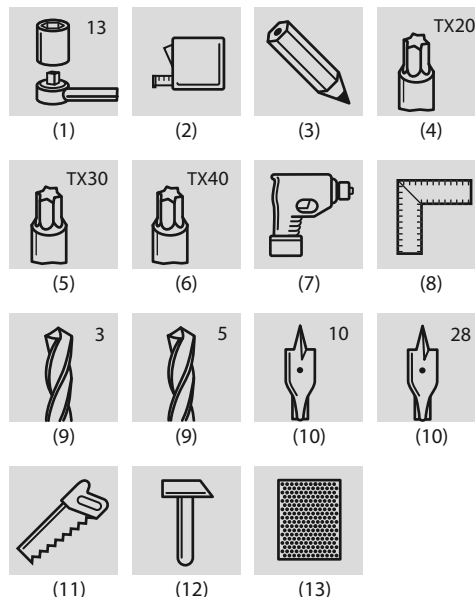

FACSAVAROK

1. lépés / A faelemek elrepedésének elkerülése érdekében javasoljuk az összes facsavarral csatlakoztatott faelem előfúrását. Mindig legalább 15 mm-el rövidebb lyukat kell fúrni, mint a csavar hossza.
Ha a csavarok átmérője 4,5 mm-es, akkor 3 mm-es átmérőjű fúróval kell előfúrni.
2. lépés / Csavarja a csavart egy két milimétert a falapba, az így előkészített elemet igazítsa a következő elemhez és együtt csavarozza össze őket.
3. lépés / A csavar becsavarásához használja a bit torx TX20-at úgy, hogy a csavar feje ne emelkedjen ki a fa felületéből.

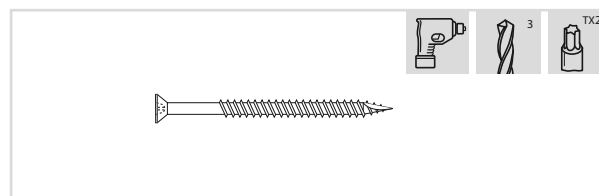

FACSAVAROS KÖTÉS

1. lépés / A faelemek elrepedésének elkerülése érdekében javasoljuk az összes facsavarral csatlakoztatott faelem előfúrását, melyek össze lesznek csavarozva. Mindig legalább 15 mm-el rövidebb lyukat kell fúrni, mint a csavar hossza. A 8 mm-es csavarhoz 5 mm-es fúróval fúrjon elő.
2. lépés / A műanyag rács alsó részébe illessze a csavart.
3. lépés / A csavar becsavarásához használja a bit torx TX20-at úgy, hogy a csavar feje ne emelkedjen ki a fa felületéből.
4. lépés / Bit torx TX40-et használva csavarja be a csavart.
5. lépés / A műanyag rács felső részét be kell húzni a lyukba.

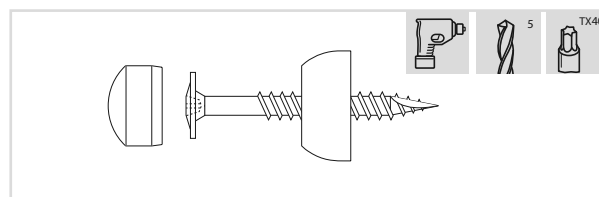

CSAVAROS KÖTÉS

1. lépés / Készítsen 10 mm átmérőjű lyukat mindkét deszkán vagy gerendán, melyek már kapcsolódnak facsavarral (lásd „facsavarok”).
2. lépés / Üsse be kalapáccsal a körmös anyát a megfelelő irányba.
3. lépés / A csavarra tegyen egy rugós alátétet, egy lapos alátétet majd az előlap alsó részét.
4. lépés / Át kell nyomni a csavart a lyukon és csavarni addig, míg a csavar bele nem csavarodik a körmös anyába.
5. lépés / Csavarja be a csavart a bit torx TX40 segítségével, úgy hogy a csavar feje teljesen fedve legyen.
6. lépés / Tegye fel a előlap felső részét.

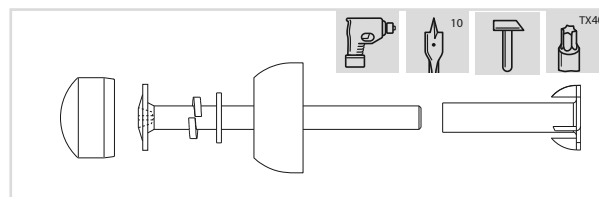

SCULE NECESARE

- (1) cheie cu clichet și cap 13 mm
- (2) ruletă
- (3) creion
- (4) cap șurubelniță TX20
- (5) cap șurubelniță TX30
- (6) cap șurubelniță TX40
- (7) mașina de găurit și/sau de înșurubat
- (8) echer
- (9) burghiu lemn \varnothing 3 și \varnothing 5 mm
- (10) burghiu rapid \varnothing 10 și \varnothing 28 mm
- (11) ferăstrău lemn
- (12) ciocan
- (13) hârtie abrazivă

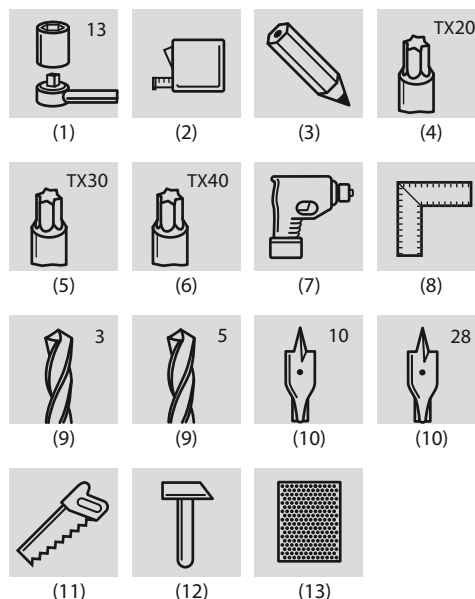

ȘURUBURI PENTRU LEMN (HOLȘURUBURI)

pasul 1/ Pentru a preveni crăparea lemnului, vă recomandăm să găuriți în prealabil toate componentele din lemn care urmează a fi îmbinate cu holșuruburi. Adâncimea găurii trebuie întotdeauna să fie cu cel puțin 15 mm mai mică decât lungimea holșurubului/șurubului.

Faceți găuri pentru holșuruburile de diametru 4,5 mm folosind burghiul de 3 mm pentru lemn.

pasul 2/ Introduceți holșurubul 1 sau 2 mm în scândura care urmează a fi fixată, iar apoi apăsați-o cu putere spre cealaltă bucată de lemn.

pasul 3/ Introduceți în lemn holșurubul cu ajutorul capului de șurubelniță Torx TX20 furnizat până când capul holșurubului ajunge la nivelul suprafeței lemnului.

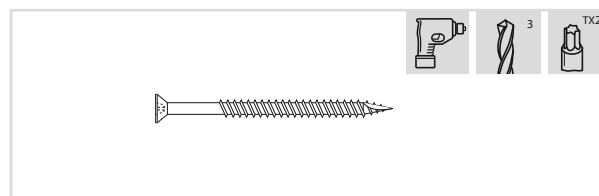

ȘURUBURI CU CAP PĂTRAT

pasul 1/ Pentru a preveni crăparea lemnului, vă recomandăm să găuriți în prealabil toate componentele din lemn care urmează a fi îmbinate cu șuruburi. Adâncimea găurii trebuie întotdeauna să fie cu cel puțin 15 mm mai mică decât lungimea holșurubului/șurubului. Faceți găuri pentru șuruburile de diametru 8 mm folosind burghiul de 5 mm pentru lemn.

pasul 2/ Introduceți pe tija șurubului șaiba plată și partea de jos a capacului de protecție.

pasul 3/ Introduceți șurubul 1 sau 2 mm în bara care urmează a fi fixată, iar apoi apăsați-o cu putere spre cealaltă bucată de lemn.

pasul 4/ Strângeți șurubul cu ajutorul capului de șurubelniță Torx TX40 furnizat.

pasul 5/ Presați partea de sus a capacului de protecție în locul prevăzut.

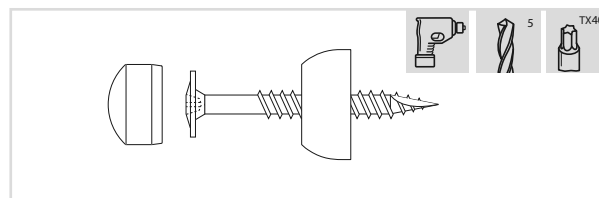

ÎMBINĂRI ȘURUB-PIULIȚĂ

pasul 1/ Faceți o gaură cu diametrul de 10 mm prin ambele scânduri sau bare care au fost deja îmbinate cu holșuruburi (vedeți 'holșuruburi')

pasul 2/ Cu ajutorul unui ciocan, presați piulița în gaura aflată pe partea indicată a barei.

pasul 3/ Introduceți pe tija șurubului inelul elastic, șaiba plată și apoi partea de jos a capacului de protecție.

pasul 4/ Împingeți șurubul prin gaură, și rotiți-l cu mâna de mai multe ori până când șurubul se rotește ușor în piulița presată.

pasul 5/ Strângeți șurubul cu ajutorul capului de șurubelniță Torx TX40 furnizat până când inelul elastic este complet aplatizat între capul șurubului și șaiba plată.

pasul 6/ Presați partea de sus a capacului de protecție în locul prevăzut.

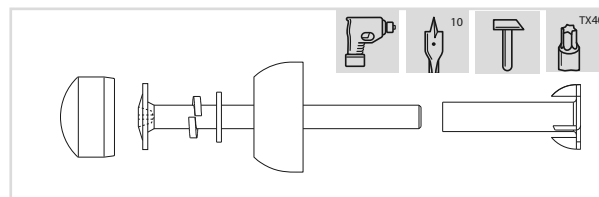

НЕОБХОДИМИ ИНСТРУМЕНТИ

- (1) тресчотка с камък 13
- (2) сантиметър
- (3) молив
- (4) бит торкс TX20
- (5) бит торкс TX30
- (6) бит торкс TX40
- (7) бормашина /или отверка
- (8) линейка
- (9) бургия ϕ 3 и ϕ 5 mm
- (10) бургия ϕ 10 и ϕ 28 mm
- (11) трион за дърво
- (12) чук
- (13) шкурка

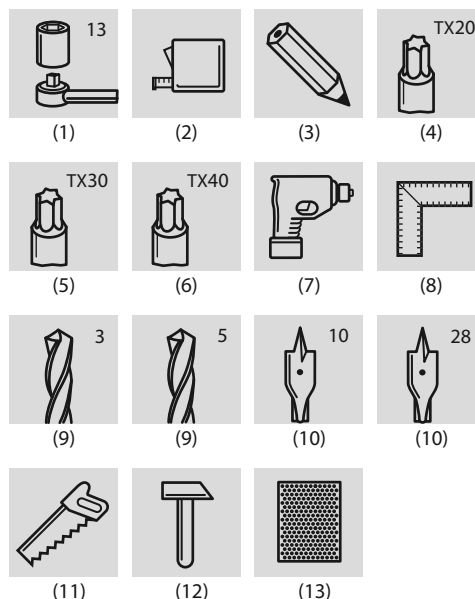

ВИНТОВЕ ЗА ДЪРВО

стъпка 1/ За да се избегнат начупвания в дървените елементи, препоръчваме предварително пробиване на всички дървени елементи, свързани с винтове. Винаги пробивайте с 15 мм по-малко от дължината на винта.

Отворите за винтовете с диаметър 4,5 мм направете с бургия с диаметър 3 мм.

стъпка 2/ Завийте винта в дъската на дълбочина 1 или 2 мм. Така приготвения елемент приложете към следващия и ги завийте заедно.
 стъпка 3/ Затегнете винта, използвайки бит торкс TX20, така че главичката на винта да не стърчи над повърхността на дървото.

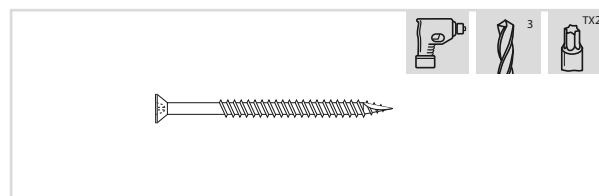

СВЪРЗВАНЕ С ВИНТ

стъпка 1/ За да се избегнат начупвания в дървените елементи, препоръчваме предварително пробиване на всички дървени елементи, които ще бъдат завивани. Винаги пробивайте с 15 мм по-малко от дължината на винта. Пробийте отвори с диаметър 8 мм с помощта на бургия с диаметър 5 мм.

стъпка 2/ Поставете плоската шайба и обратната страна на защитната капачка на винта.

стъпка 3/ Първо, завийте винта на 1-2 мм в дъската, така приготвения елемент приложете към следващия елемент и ги завийте заедно.

стъпка 4/ Затегнете винта с помощта на бит торкс TX40.

стъпка 5/ Притиснете горната част на защитната капачка в отвора.

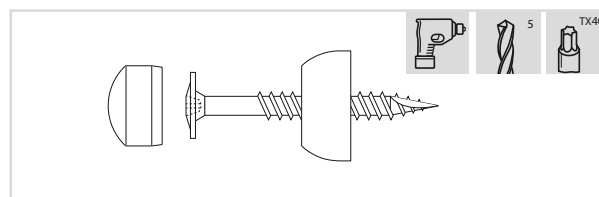

СВЪРЗВАНЕ С БОЛТ

стъпка 1/ Пробийте отвор с диаметър 10 мм в двете дъски или греди, които вече са свързани с винтове (виж "винтове за дърво")

стъпка 2/ Забийте с чук втулката с вътрешна резба с подходящата страна в отвора.

стъпка 3/ Поставете върху болта пружинен пръстен, плоската шайба, а след това долната част на защитната капачка.
 стъпка 4/ Вкарайте болта в отвора и завивайте докато болта започне да влиза в гайката.

стъпка 5/ Затегнете болта с помощта на бит торкс TX40, така че главата на болта да е напълно скрита.

стъпка 6/ Поставете горната част на защитната капачка.

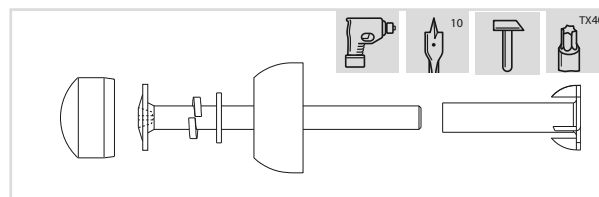

REIKALINGI ĮRANKIAI

- (1) veržliaraktis 13 (terkšlė)
- (2) matuoklis
- (3) pieštukas
- (4) bit torx TX20
- (5) bit torx TX30
- (6) bit torx TX40
- (7) grąžtas/arba atsuktuvus
- (8) kampainis
- (9) medžio grąžtas $\varnothing 3$ i $\varnothing 5$ mm
- (10) grąžtas plunksninis $\varnothing 3$ i $\varnothing 5$ mm
- (11) plaktukas
- (12) švitrinis popierus

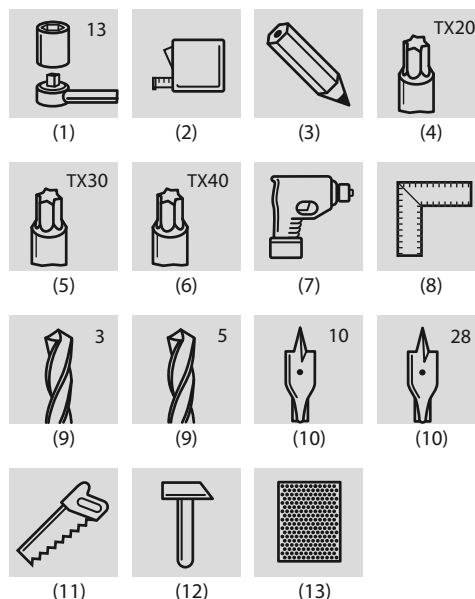

MEDŽIO VARŽTAI

1 žingsnis / Kad neiširtų medžio elementai, rekomenduojame padaryti pradinius gręžimus visuose medžio elementuose, sujungtuose varžtais. Reikia visada gręžti bent 15 mm trumpiau nei varžto ilgis .

Skylę varžtams įsukti, kurių skersmuo 4,5 mm, reikia atlikti 3 mm skersmens grąžtu.

2 žingsnis / Įsukite varžtą vieną arba du mm į lentą, taip paruoštą elementą pridėkite prie sekančio elemento ir susukite juos kartu.

3 žingsnis/ Įsukite varžtą naudojant bit torx TX20 taip, kad varžto galvutė neišsikištų virš medžio paviršiaus.

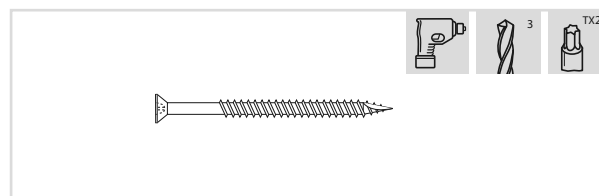

JUNGIMAS VARŽTAIS

1 žingsnis/ Kad neiširtų mediniai elementai, rekomenduojame atlikti įžanginius gręžimus mediniuose elementuose, kurie bus sujungti. Reikia visada gręžti bent 15 mm trumpiau nei varžto ilgis. Išgręžti skylės varžtams įsukti, 8 mm skersmeniui naudokite 5mm grąžtą.

2 žingsnis/ Į apatinę plastmasinės maskuotės dalį įdėkite varžtą.

3 žingsnis/Pirmiausia įsukite varžtą vieną arba du mm gylį į lentą, taip paruoštą elementą pridėkite prie sekančio elemento ir susukite juos kartu.

4 žingsnis/ Įsukite varžtą naudojant bit torx TX40.

5 žingsnis/ Viršutinę maskuotės dalį įspauskite į angą.

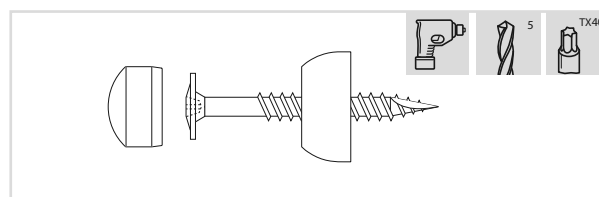

JUNGIMAS SRAIGTU

1 žingsnis/ Padarykite 10 mm skersmens angą abiejose lentose arba rąstuose, kurie jau yra sujungti varžtais (žiūrekite „Medžio varžtai“).

2 žingsnis/ Įkalkite plaktuku veržlę sriegine galvute atitinkama puse į angą.

3 žingsnis/ Ant sraigto uždėkite savikontrolinį padėklą, plokščią padėklą ir apatinę maskuotės dalį.

4 žingsnis/ Pastumkite sraigto galvutę per angą ir sukite, kol varžtas pradės įsisukti į ratinę veržlę.

5 žingsnis/ Prisukite varžtą su bit torx TX40 pagalba taip, kad sraigto galvutė visiškai pasislėptų.

6 žingsnis/ Uždėkite viršutinę maskuotės dalį.

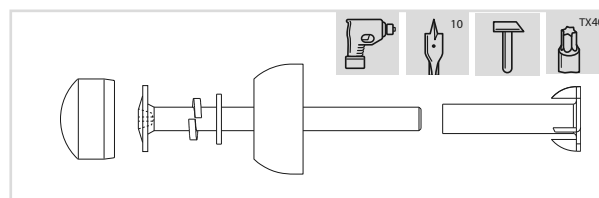

NEPIECIEŠAMIE RĪKI

- (1) Sprūdatslēga ar vāciņu 13
- (2) Mērlente
- (3) Zīmulis
- (4) Zvaigžņveida atslēga TX20
- (5) Zvaigžņveida atslēga TX30
- (6) Zvaigžņveida atslēga TX40
- (7) Urbis un skrūvgriezis
- (8) Leņķmērs
- (9) Koka urbja uzgali $\varnothing 3$ un $\varnothing 5$ mm
- (10) Ātrās fiksācijas urbja uzgali $\varnothing 10$ un $\varnothing 28$ mm
- (11) Koka zāģis
- (12) Āmurs
- (13) Smilšpapīrs

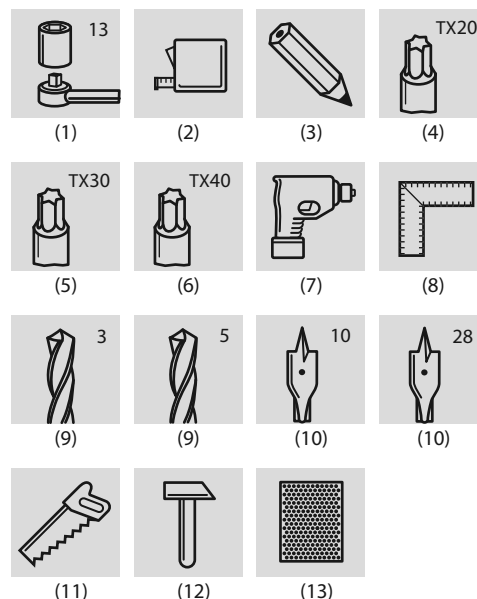

KOKA SKRŪVES

1. darbība/ Lai novērstu koka plaisāšanu, ieteicams iepriekš izurbt caurumu visās koka daļās, kur tiks ievietotas skrūves. Vienmēr urbiet vismaz 15 mm seklāk par skrūves garumu.

Vietu koka skrūvēm ar diametru 4,5 mm izurbiet ar 3 mm koka urbi.

2. darbība/ Vispirms pagrieziet skrūvi par vienu vai diviem milimetriem dēlī, kas jāpieskrūvē, pēc tam spiediet to cieši pret citu koka daļu.

3. darbība/ Pievelciet skrūvi ar zvaigžņveida uzgali TX20 kokā, līdz skrūves galviņa ir vienā līmenī ar koka virsmu.

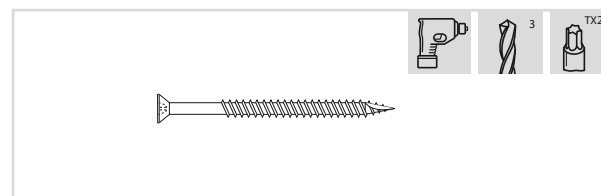

SKRŪVES AR KVADRĀTVEIDA GALVIŅU

1. darbība/ Lai novērstu koka plaisāšanu, ieteicams iepriekš izurbt caurumu visās koka daļās, kas jāpieskrūvē. Vienmēr urbiet vismaz 15 mm seklāk par skrūves garumu. Iepriekš izurbiet vietu skrūvēm ar kvadrātveida galviņu un diametru 8 mm, izmantojot 5 mm koka urbi.

2. darbība/ Novietojiet plakano starpliku un aizsargvāciņa pamatni uz skrūves kāta.

3. darbība/ Vispirms pagrieziet skrūvi par vienu vai diviem milimetriem dēlī, kas jānostiprina, pēc tam spiediet stingri pret citu koka daļu.

4. darbība/ Pievelciet skrūvi ar komplektācijā iekļauto zvaigžņveida atslēgu TX40.

5. darbība/ Iespiediet aizsargvāciņa virsmu izveidotajā atverē.

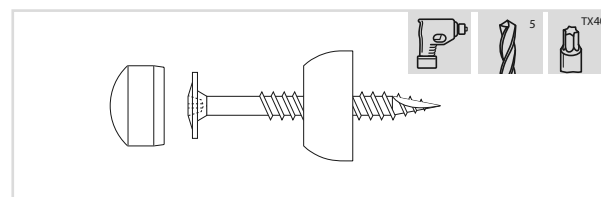

SKRŪVJU SAVIENOJUMI

1. darbība/ Izurbiet caurumu ar diametru 10 mm caur abiem dēļiem vai sijām, kas jau ir saskrūvētas kopā (skatiet tēmu par koka skrūvēm).

2. darbība/ Iesiet uzgriezni ar āmuru gar sijas paredzēto vietu atverē.

3. darbība/ Novietojiet atsperveida atdures gredzenu, plakano starpliku un aizsargvāciņa apakšējo daļu uz skrūves kāta.

4. darbība/ Iestumiet skrūvi atverē un pagrieziet to vairākas reizes ar roku, līdz skrūve viegli iegriežas iespiestajā uzgrieznī.

5. darbība/ Pievelciet skrūvi ar komplektācijā iekļauto zvaigžņveida atslēgu TX40, līdz atsperveida atbalsta gredzens ir pilnībā plakans starp skrūves galviņu un plakano starpliku.

6. darbība/ Iespiediet aizsargvāciņa augšējo daļu izveidotajā atverē.

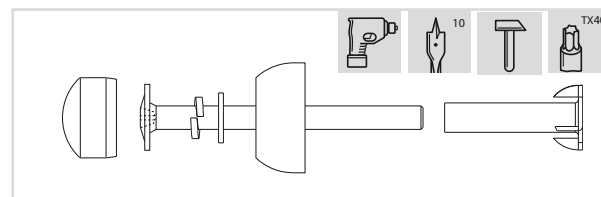

VAJALIKUD TÖÖRIISTAD

- (1) pörmehhanismiga mutrivõti koos padruniga 13
- (2) mõõtelint
- (3) pliats
- (4) torx-otsik TX20
- (5) torx-otsik TX30
- (6) torx-otsik TX40
- (7) puur ja/või kruvikeeraja
- (8) nurgik
- (9) puidupuurid \varnothing 3 ja \varnothing 5 mm
- (10) kiirpuurid \varnothing 10 ja \varnothing 28 mm
- (11) puidusaag
- (12) haamer
- (13) liivapaber

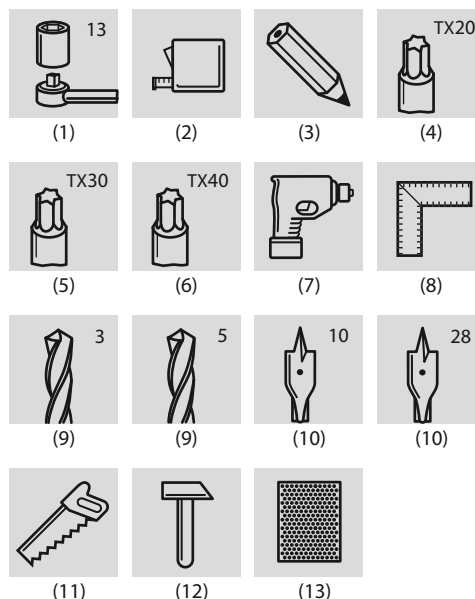

PUIDUKRUIVID

- 1. samm / Pindude ja kildude lahtitulemise vältimiseks soovitame kõik puitdetailid enne kruvidega ühendamist ette puurida. Puurige kruvi pikkusega võrreldes alati 15 mm madalam auk. 4,5 mm läbimõõduga puidukruvidele peab ette puuritava augu läbimõõt olema 3 mm.
- 2. samm / Keerake kruvi esmalt üks või kaks millimeetrit kinnitava laua sisse; seejärel suruge see tugevalt vastu teist puitdetaili.
- 3. samm / Pingutage kruvi kaasasoleva torx-otsikuga kuni kruvi pea on puidu pinnaga samas tasapinnas.

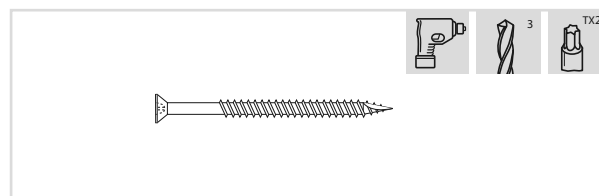

SUURED PUIDUKRUIVID

- 1. samm / Pindude ja kildude lahtitulemise vältimiseks soovitame kõik puitdetailid enne kruvidega ühendamist ette puurida. Puurige kruvi pikkusega võrreldes alati 15 mm madalam auk. 8 mm läbimõõduga puidukruvidele peab ette puuritava augu läbimõõt olema 5 mm.
- 2. samm / Asetage lameseib ja kaitsekorgi põhi üle kruvi keskosa.
- 3. samm / Keerake kruvi esmalt üks või kaks millimeetrit kinnitava tala sisse; seejärel suruge see tugevalt vastu teist puitdetaili.
- 4. samm / Pingutage kruvi kaasasoleva torx-otsikuga TX40.
- 5. samm / Vajutage kaitsekorgi pealisosa selleks ettenähtud avasse.

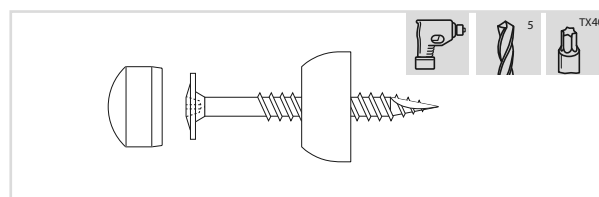

POLTÜHENDUSED

- 1. samm / Puurige 10 mm läbimõõduga ava läbi laudade või talade, mis on omavahel juba kokku kruvitud (vt „puidukruvid“).
- 2. samm / Lööge sisse tõmmatav mutter haamriga mööda tala ettenähtud külge ava sisse.
- 3. samm / Asetage poldile rõngasvedru, lameseib ja seejärel kaitsekorgi alumine osa.
- 4. samm / Suruge polt läbi ava ja keerake käega mitu korda kuni polt haakub sujuvalt sisse tõmmatavasse mutrisse.
- 5. samm / Pingutage polti kaasasoleva torx-otsikuga TX40 kuni rõngasvedru on poldi pea ja lameseibi vahel täielikult lamedaks surutud.
- 6. samm / Vajutage kaitsekorgi pealisosa selleks ettenähtud avasse.

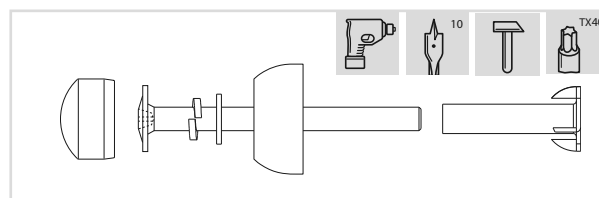

ТРЕБУЕМЫЕ ИНСТРУМЕНТЫ

- (1) ключ с трещёткой и крышкой 13
- (2) сантиметр
- (3) карандаш
- (4) винт torx TX20
- (5) винт torx TX30
- (6) винт torx TX40
- (7) свёрла и/или отвёртка
- (8) линейка
- (9) дрель для винтов $\text{R} 3$ и $\text{R} 5$ mm
- (10) свёрло для винтов $\text{R} 10$ и $\text{R} 28$ mm
- (11) пила для дерева
- (12) молоток
- (13) наждачная бумага

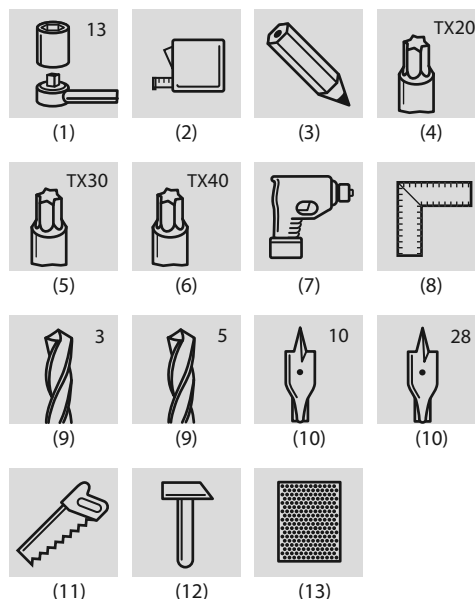

ВИНТЫ ДЛЯ ДЕРЕВА

шаг 1/ Чтобы избежать расколов в деревянных деталях, мы рекомендуем провести черновое сверление в местах соединения шурупами. Всегда просверливайте как минимум на 15 мм меньше длины шурупа. Сделайте черновое сверление диаметром 4,5 мм при помощи 3 мм сверла для дерева.
 Шаг 2/ Сперва вкрутите шуруп в планку на глубину 1 или 2 мм, затем крепко прижмите ко второй деревянной планке.
 Шаг 3/ Вкручивайте винт в дерево при помощи биты torx TX20, прилагающейся в комплекте, до тех пор пока головка винта не сравняется с поверхностью деревянной планки.

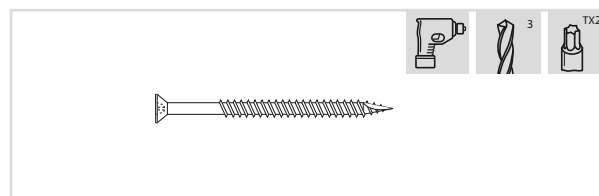

ШУРУПЫ С ШЕСТИГРАННОЙ ГОЛОВКОЙ

шаг 1/ Чтобы уберечь деревянные детали от трещин, мы рекомендуем произвести черновое сверление в местах соединения шурупами. Всегда просверливайте как минимум на 15 мм меньше чем длина шурупа. Сделайте черновое сверление диаметром 8 мм при помощи 5 мм сверла для дерева.
 шаг 2/ Положите плоскую шайбу и обратную сторону предохранительного колпачка на стержень шурупа.
 шаг 3/ Сперва вкрутите шуруп на 1-2 мм в бревно для безопасности, затем крепко прижмите к другому бревну.
 шаг 4/ Закрепите шуруп с помощью биты torx TX20, что идет в комплекте.
 шаг 5/ Прижмите верх защитного колпачка в соответствующее отверстие.

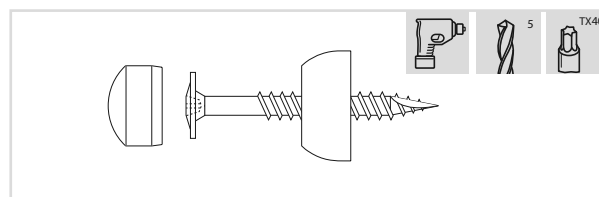

СОЕДИНЕНИЕ ВИНТОВ

шаг 1/ Просверлите отверстие диаметром 10 мм сквозь обе планки или бревна, которые уже были скручены шурупами вместе (смотреть "шурупы для дерева")
 шаг 2/ Забейте втулку с внутренней резьбой при помощи молотка в отверстие вдоль назначенной стороны бревна.
 шаг 3/ Поместите пружинное кольцо, плоскую шайбу, а затем нижнюю часть защитного колпачка на стержень болта.
 шаг 4/ Протолкните болт сквозь отверстие и проверните рукой несколько раз до тех пор, пока болт не начнет легко проворачиваться в запрессованную гайку.
 шаг 5/ Закрепите болт с помощью биты torx TX40, что идет в комплекте, до тех пор, пока пружинное кольцо не будет плотно прилегать между головок болта и плоской шайбой.
 шаг 6/ Прижмите верх защитного колпачка к соответствующему отверстию.

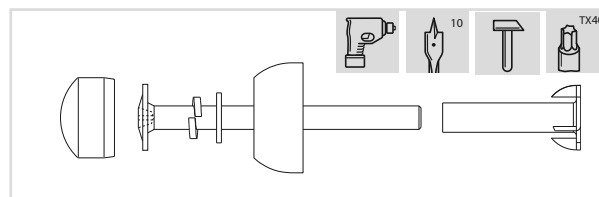

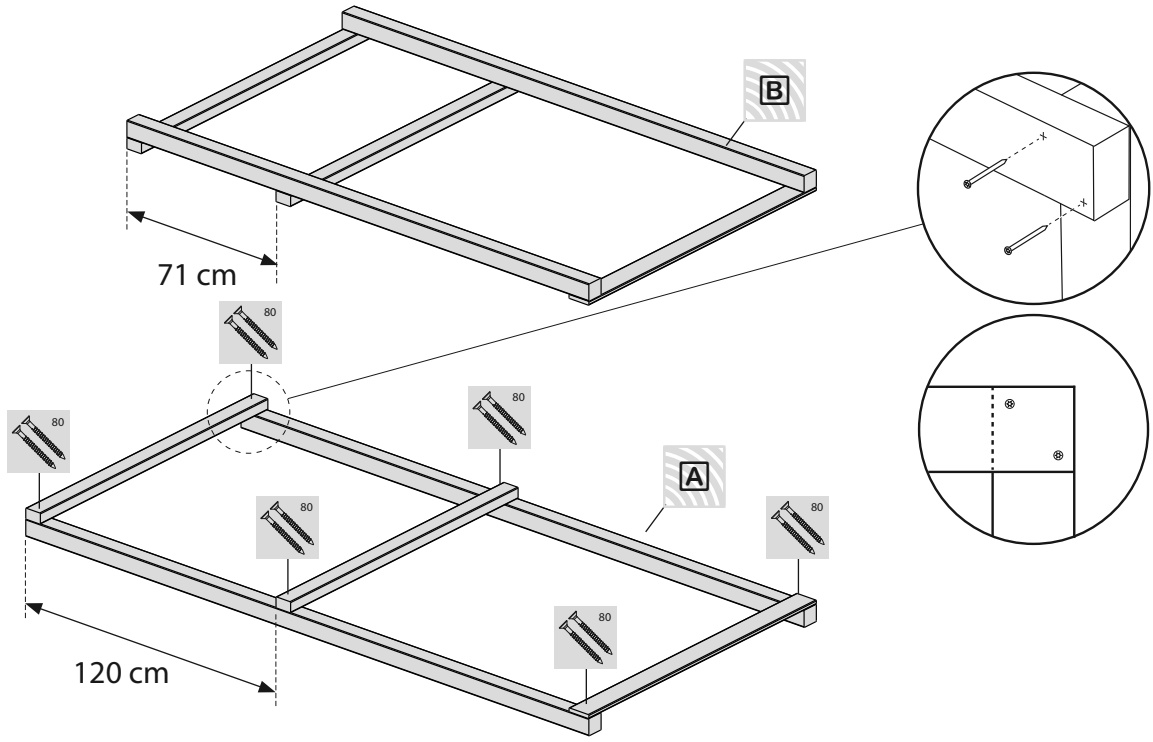

- A** 2x
- B** 2x
- H** 4x
- R** 2x
-  12x



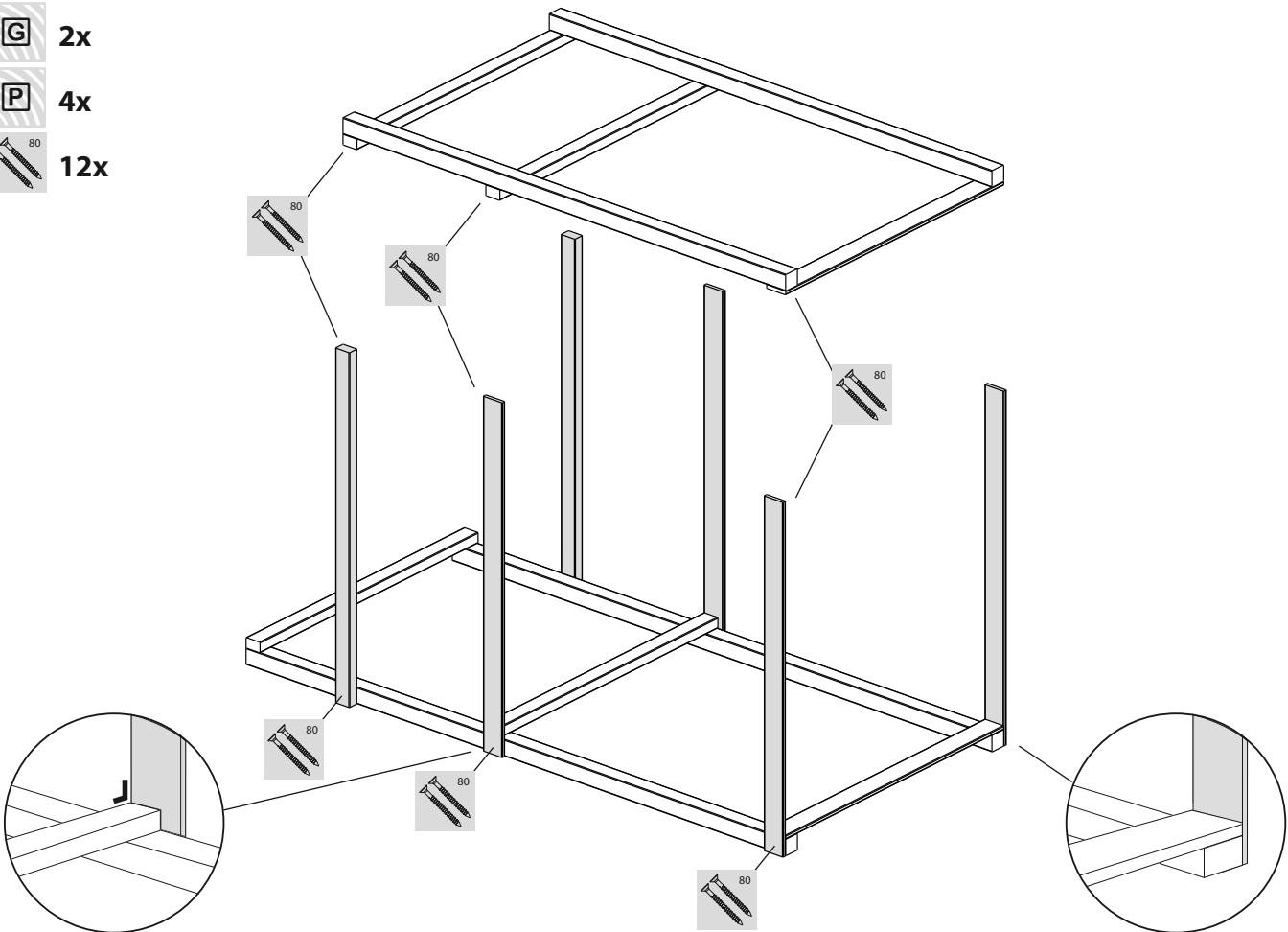

- G** 2x
- P** 4x
-  12x

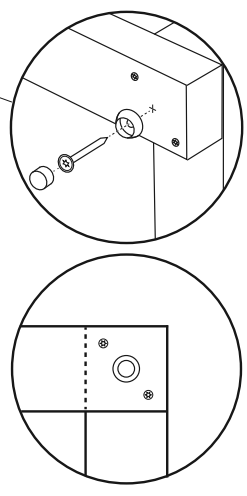
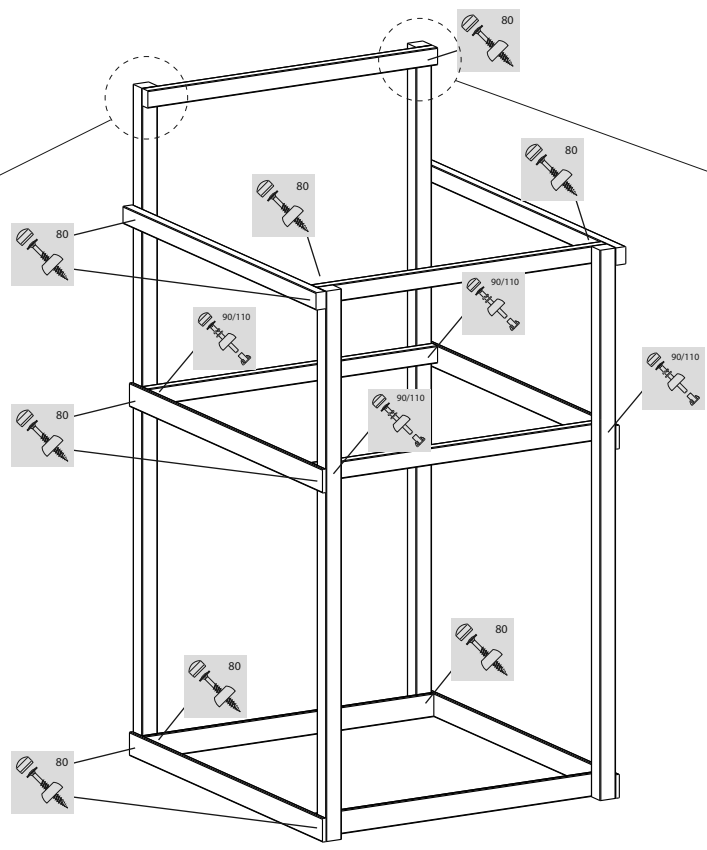
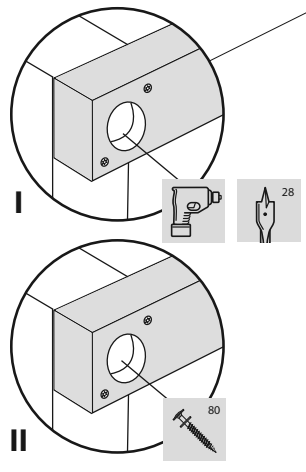

-  80 **1x**
-  80 **19x**
-  90/110 **4x**



-  **1x**
-  80 **2x**

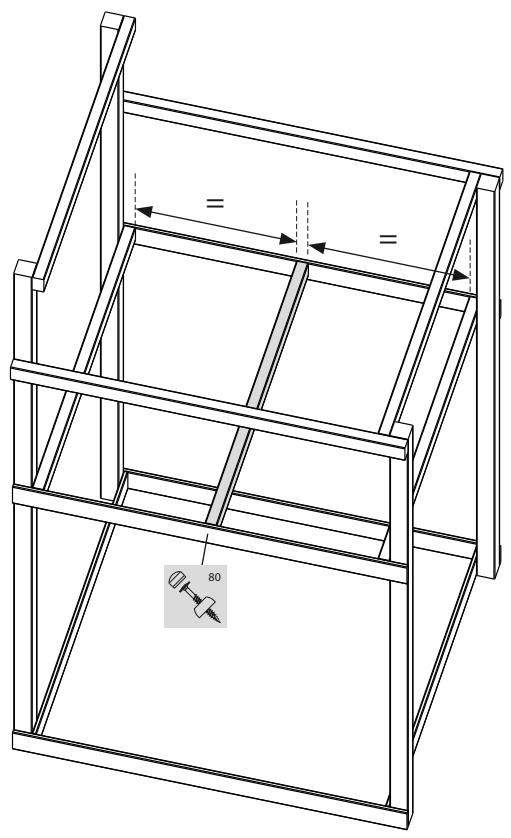

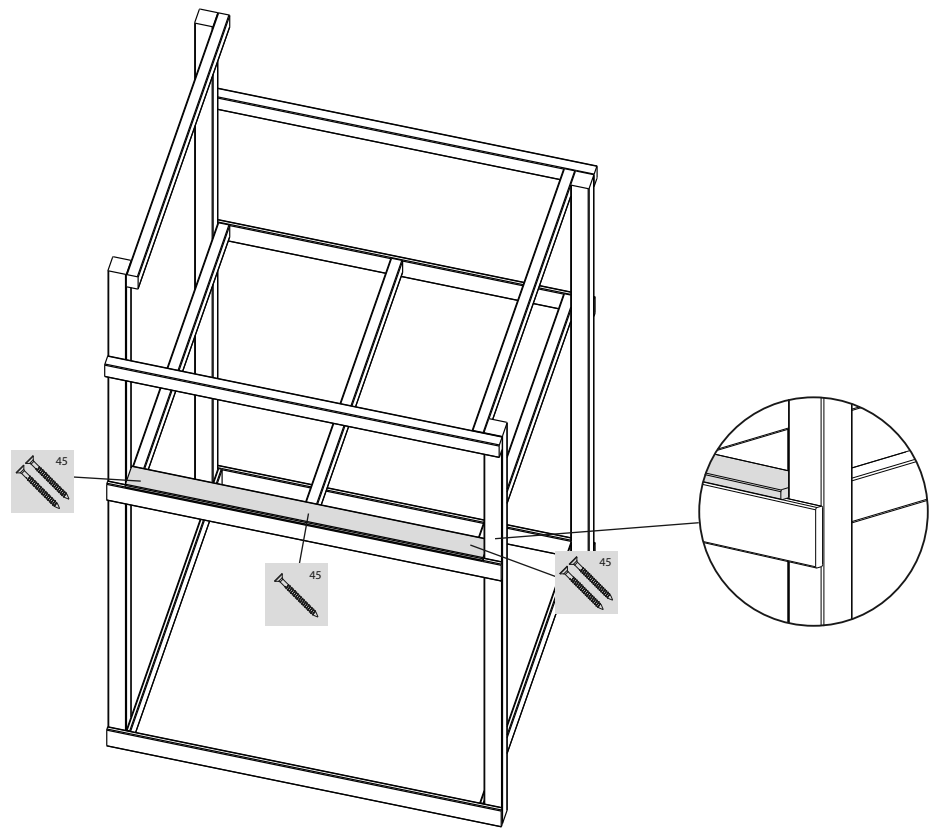

5a

-  1x
-  2x
-  1x





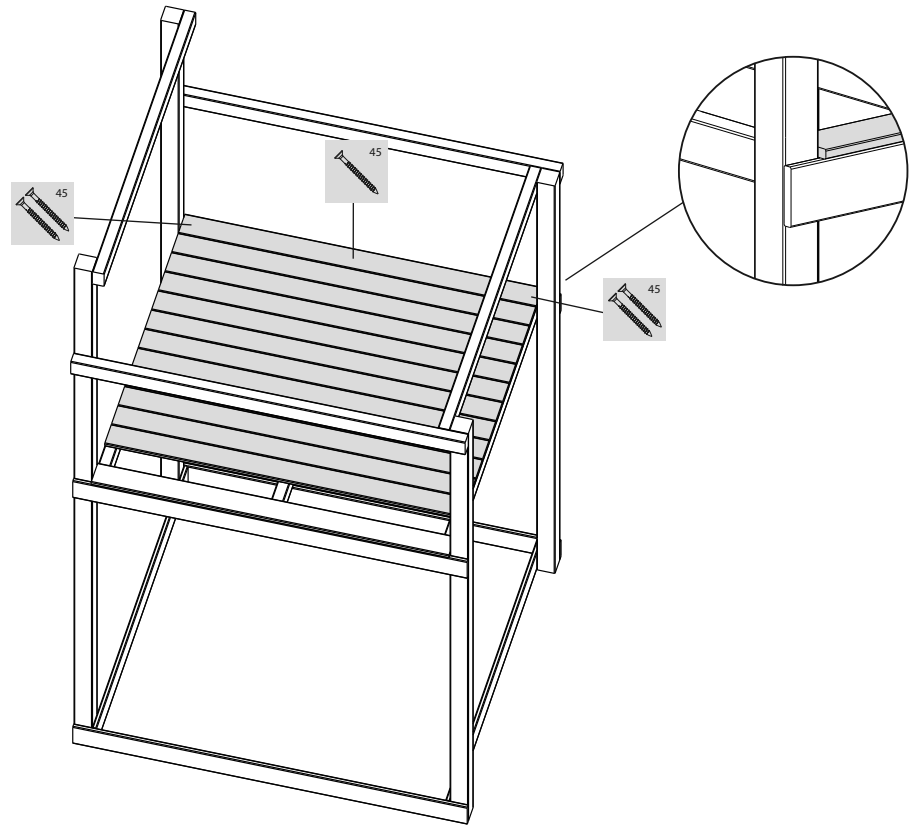

5b

-  8x/12x
-  24x
-  12x

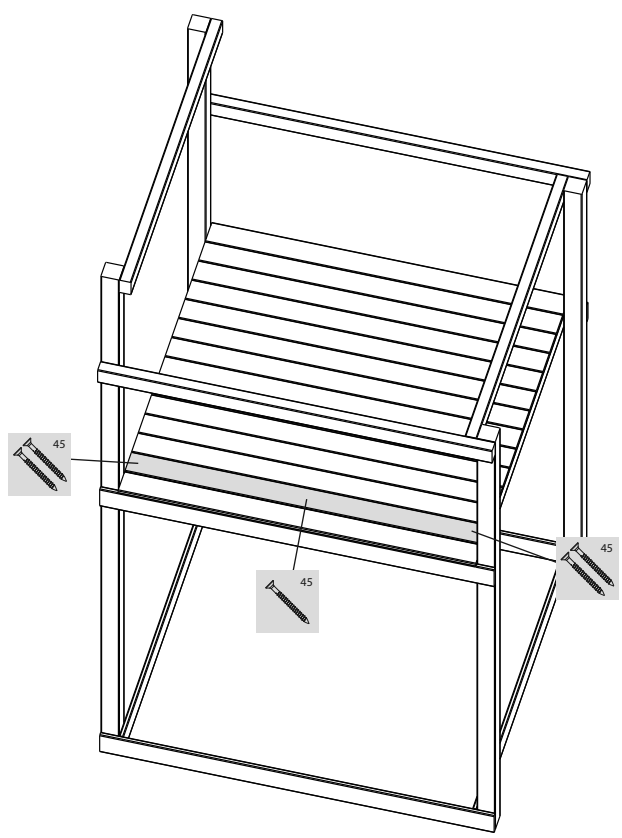
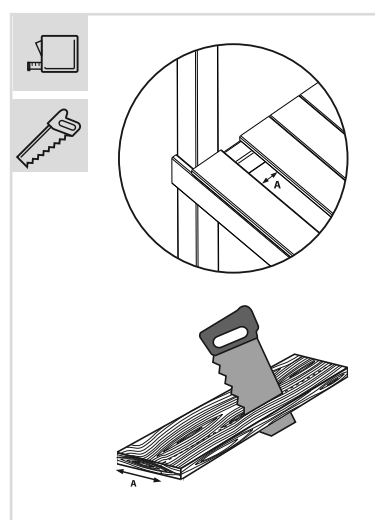

-  **1x**
-  **2x**
-  **1x**



-  **2x**
-  **3x 4x**
-  **8x**

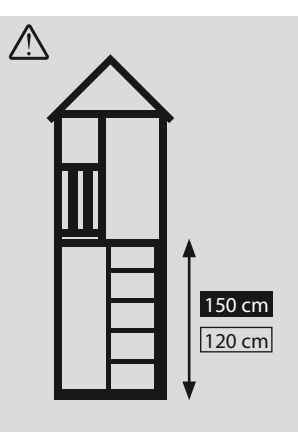
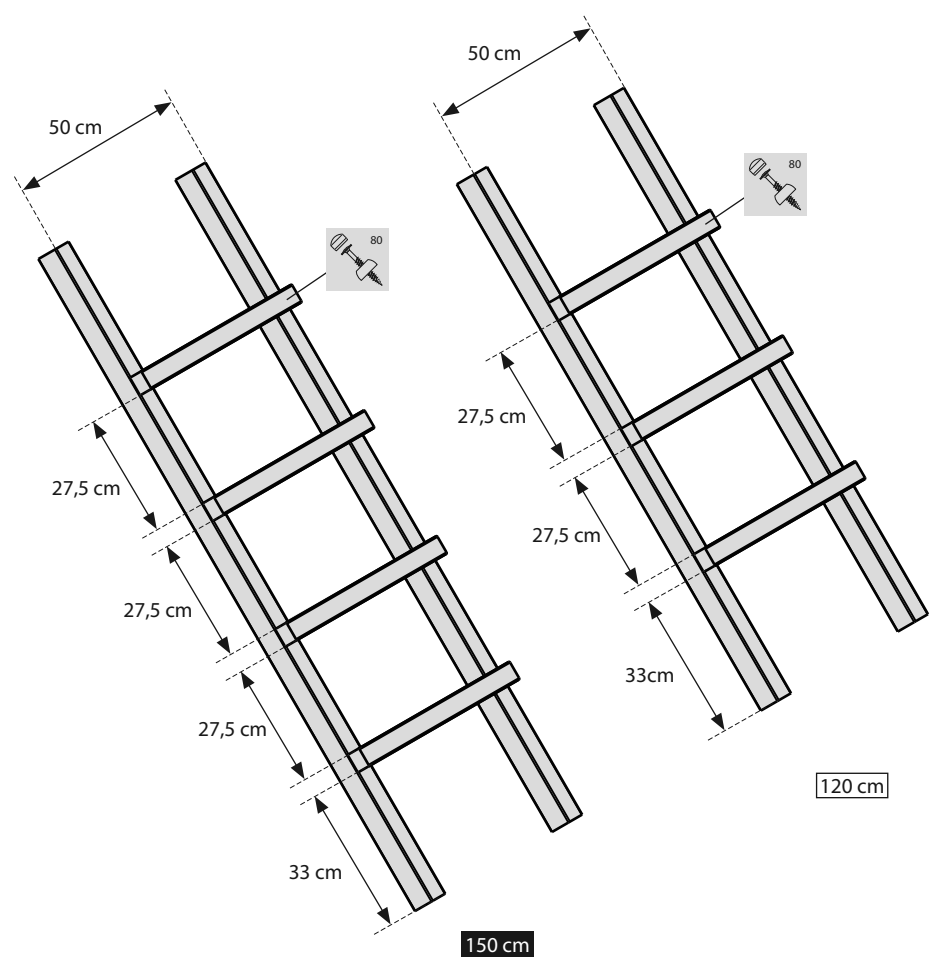



1x

6b

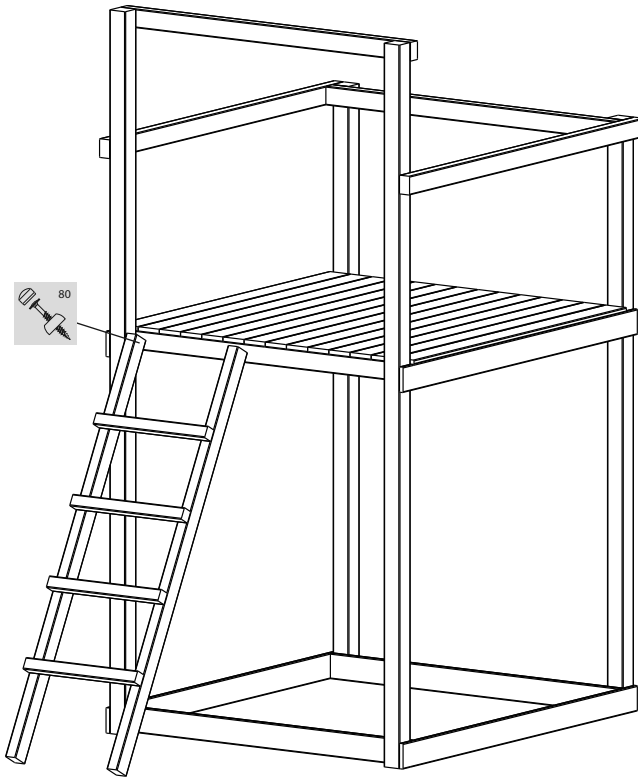
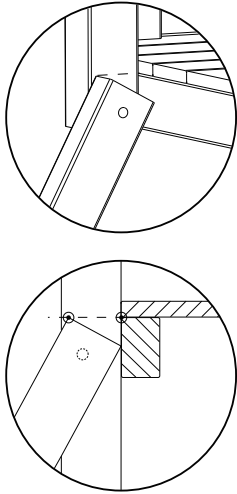

1x



1x



2x

7

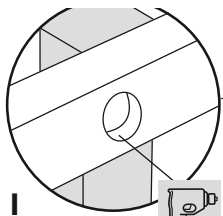

I

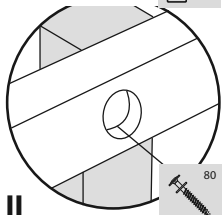

II

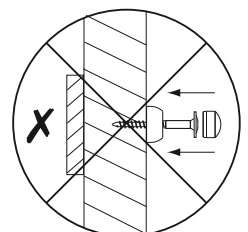
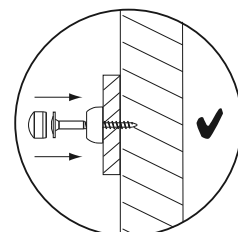
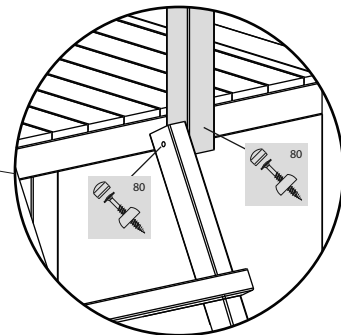
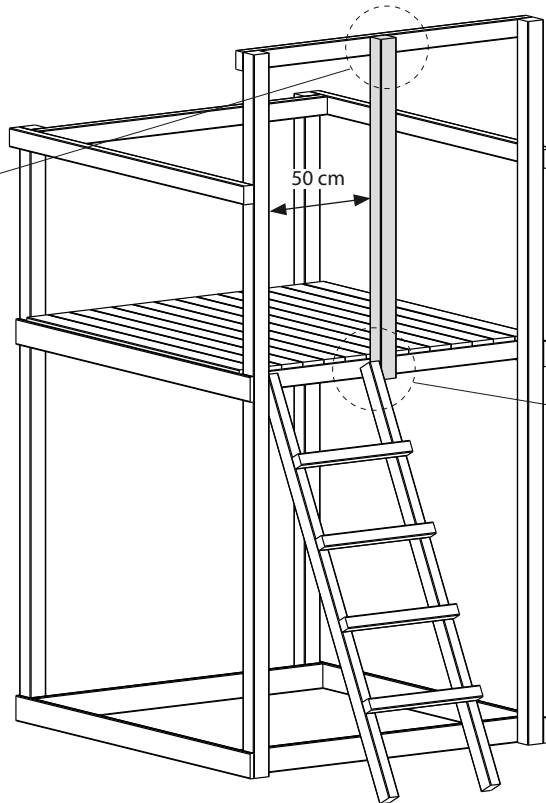

-  1x
-  2x

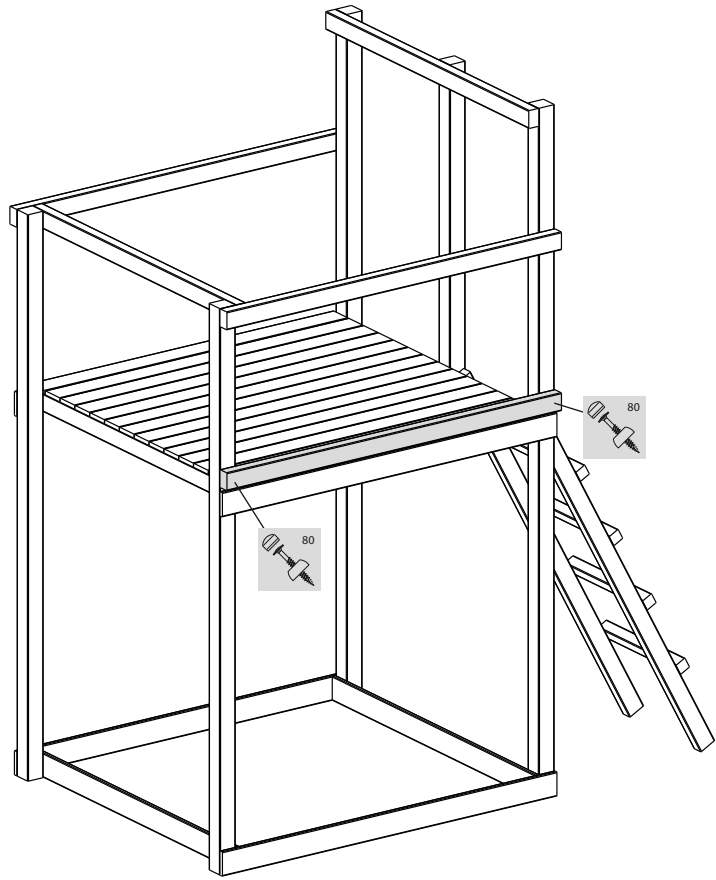

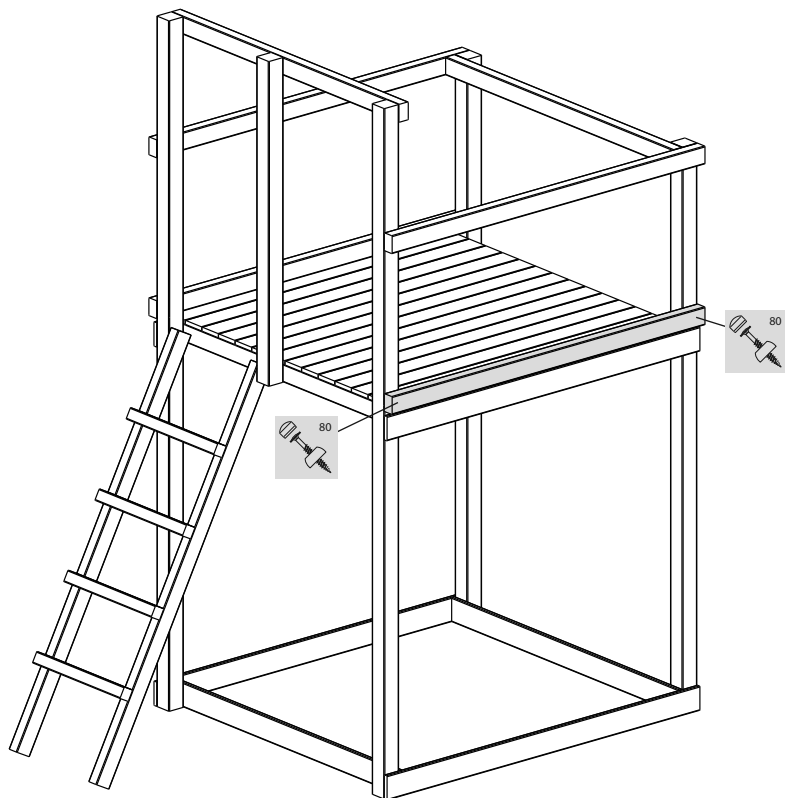

-  1x
-  2x



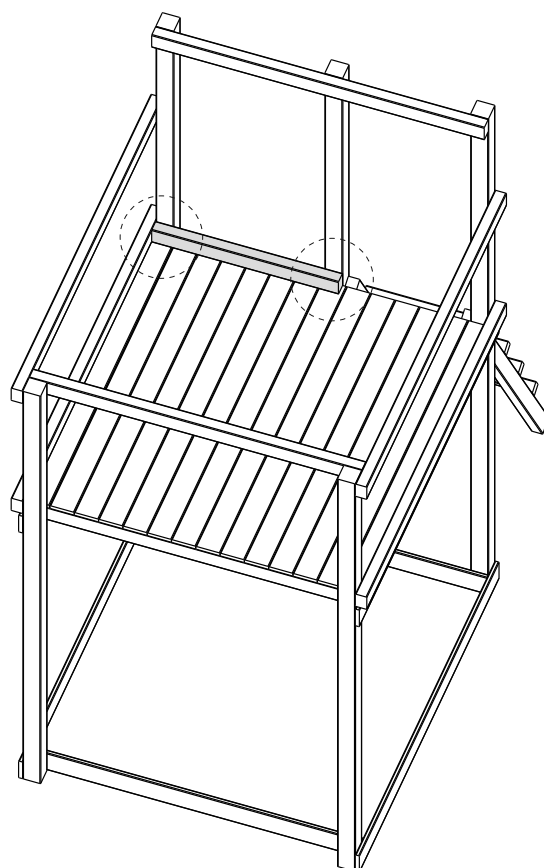
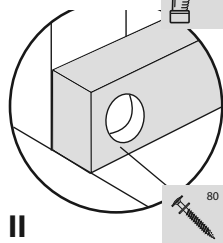
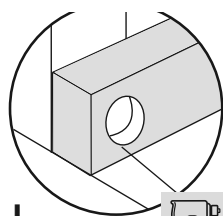

-  1x
-  80 2x



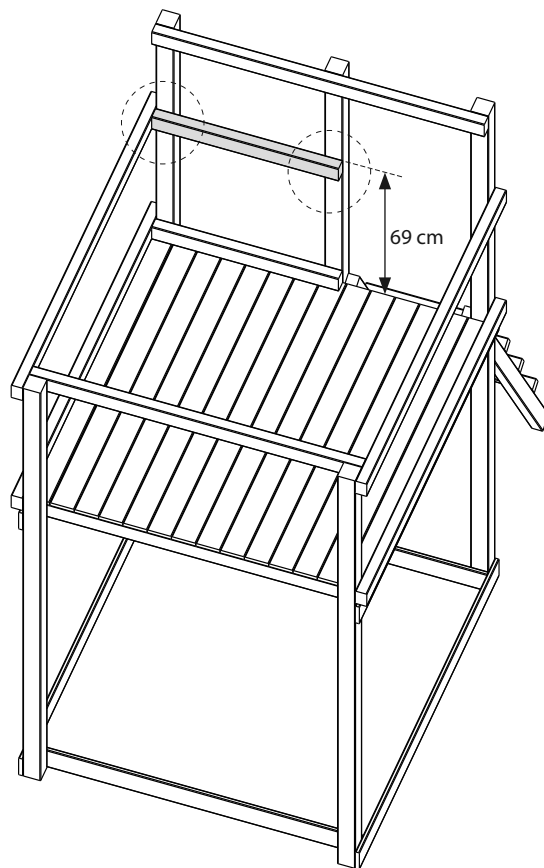
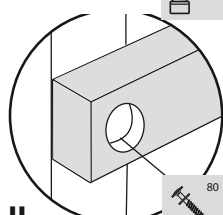
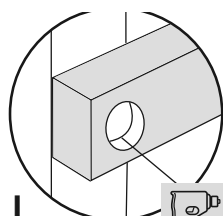





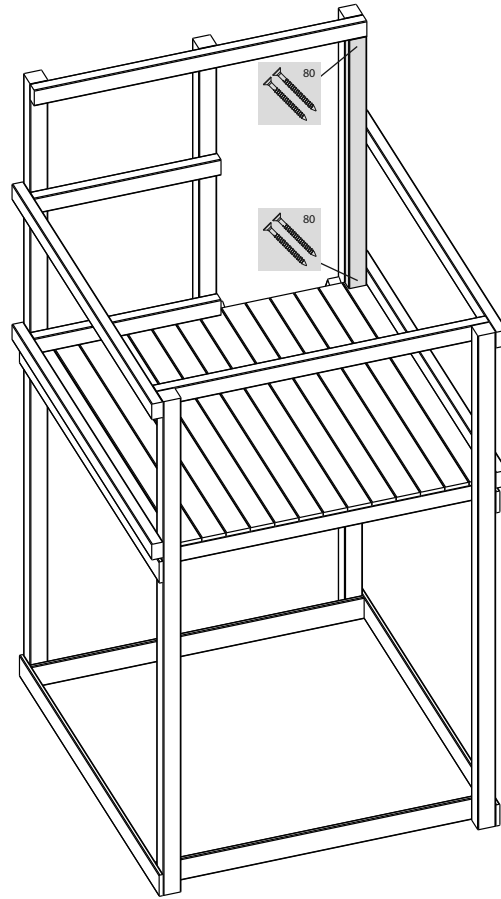

-  1x
-  80 2x









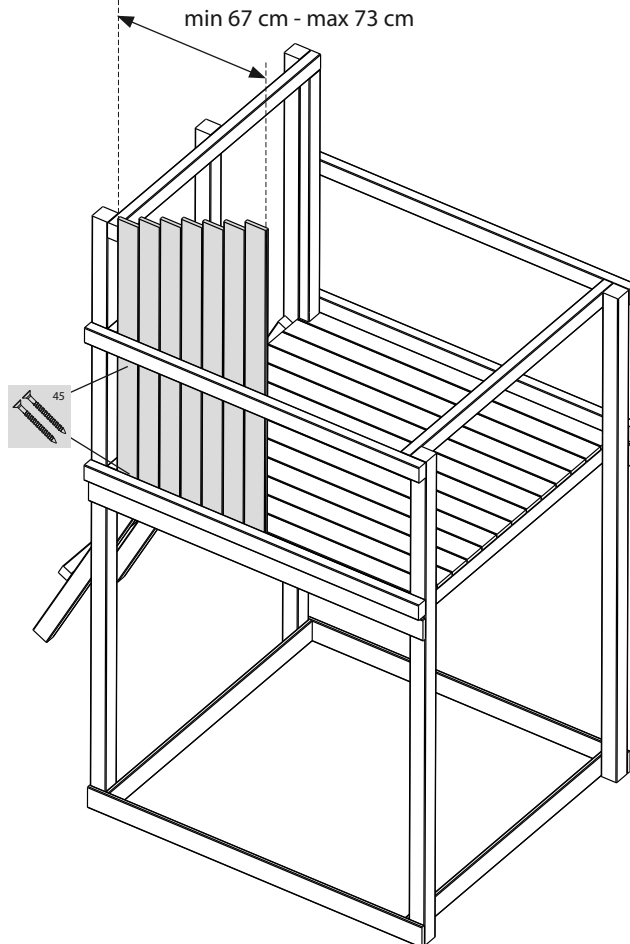

-  **1x**
-  **2x**





-  **1x**
-  **1x**
-  **1x**
-  **1x**
-  **1x**
-  **(1x)**
-  **(1x)**
-  **14x**



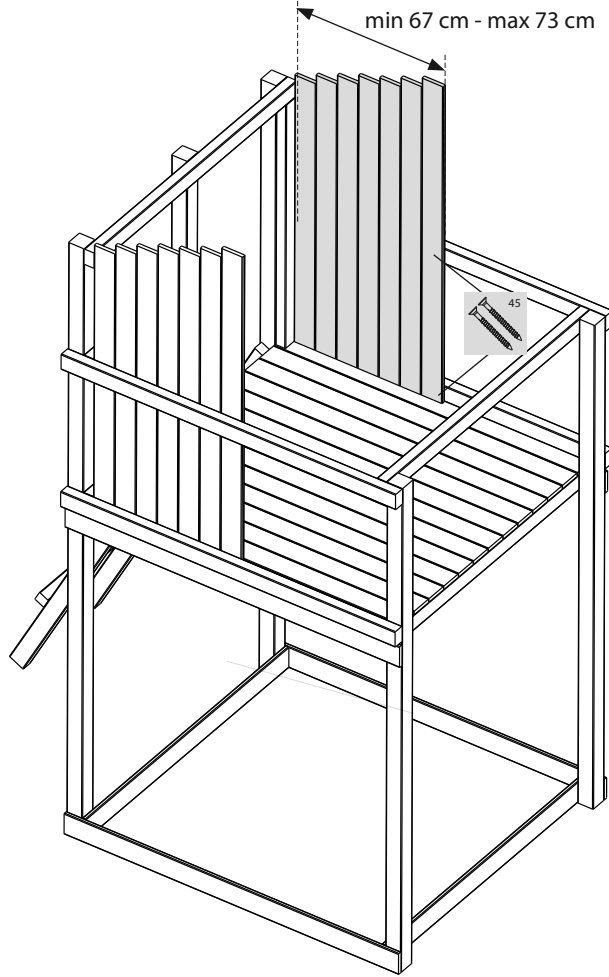

-  **1x**
-  **1x**
-  **1x**
-  **1x**
-  **1x**
-  **(1x)**
-  **(1x)**
-  **14x**

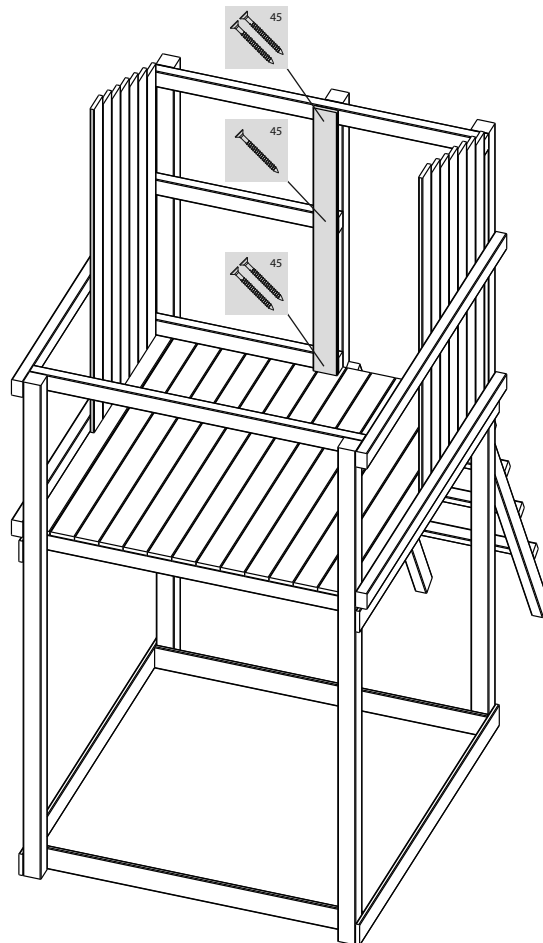

-  **1x**
-  **2x**
-  **1x**



-  **3x/6x**
-  **12x**
-  **6x**

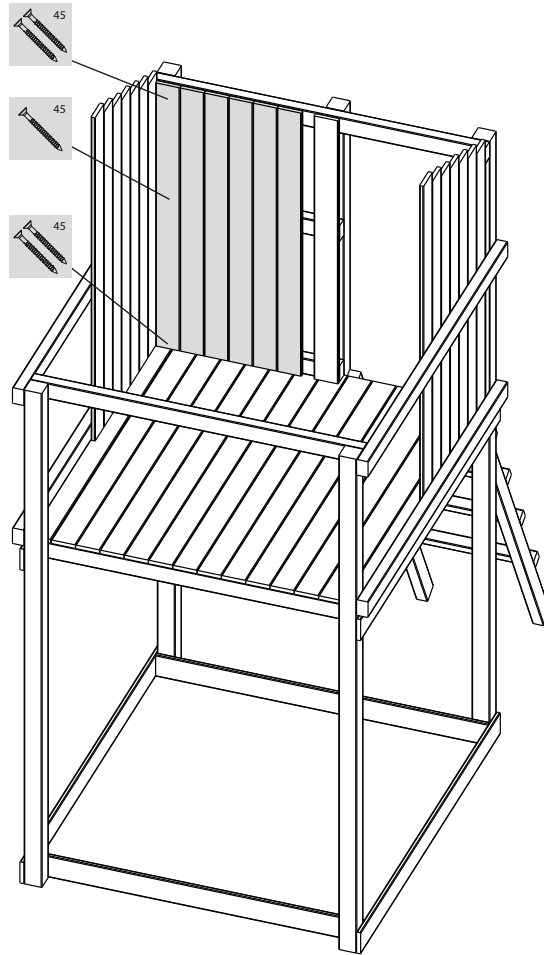

-  **1x**
-  **2x**
-  **1x**

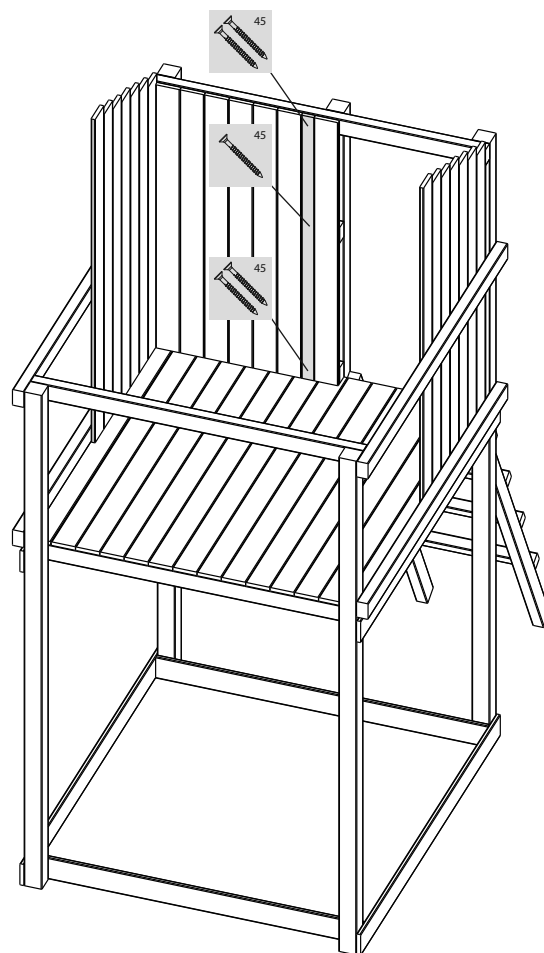
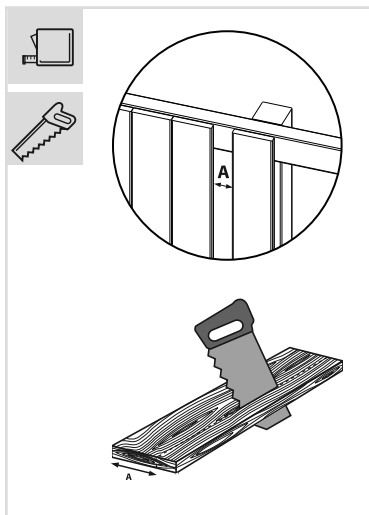

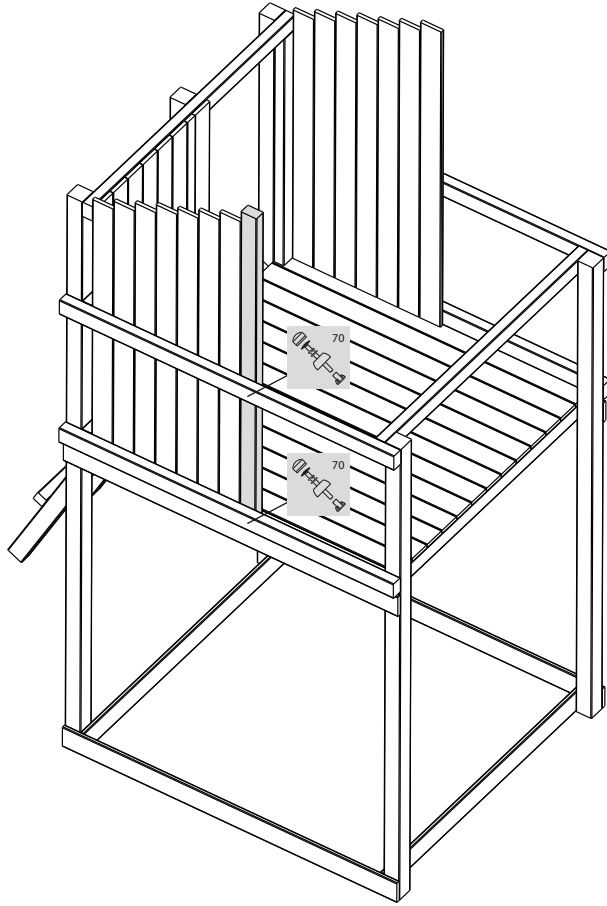

-  1x
-  2x



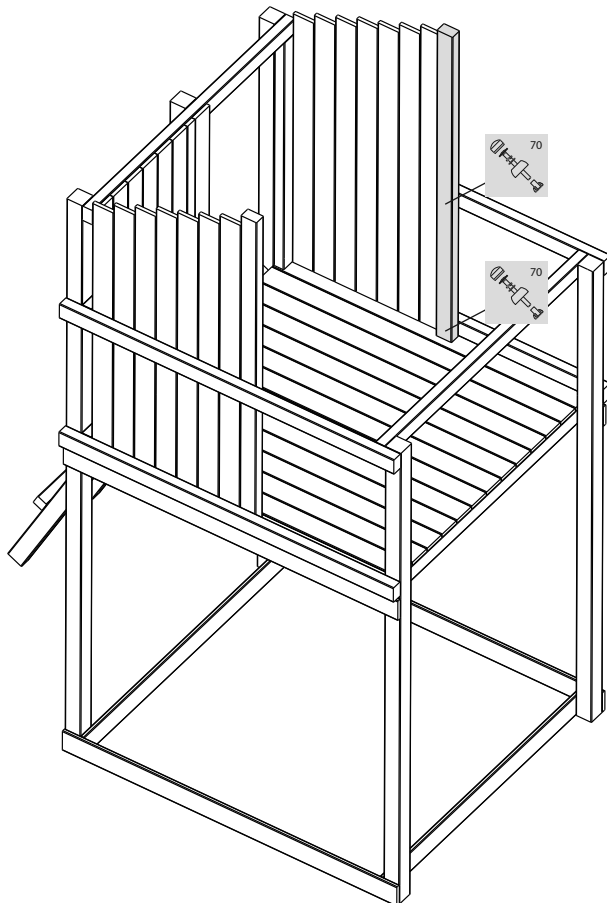

-  1x
-  2x

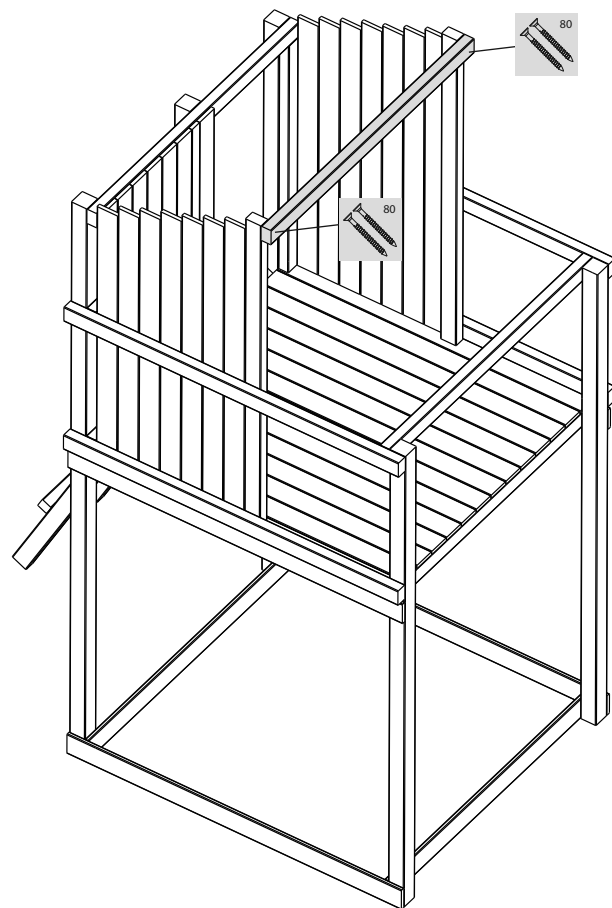

-  1x
-  2x



-  1x/2x
-  2x

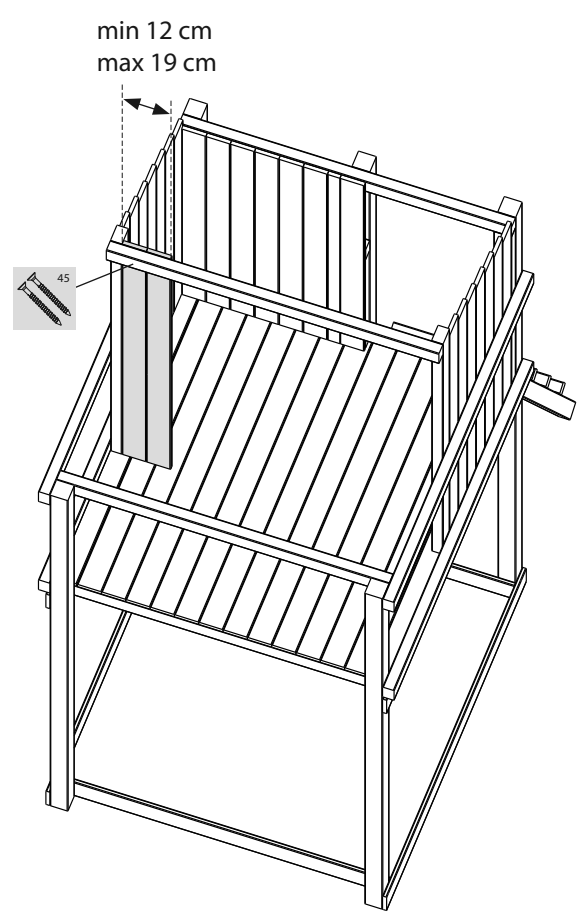

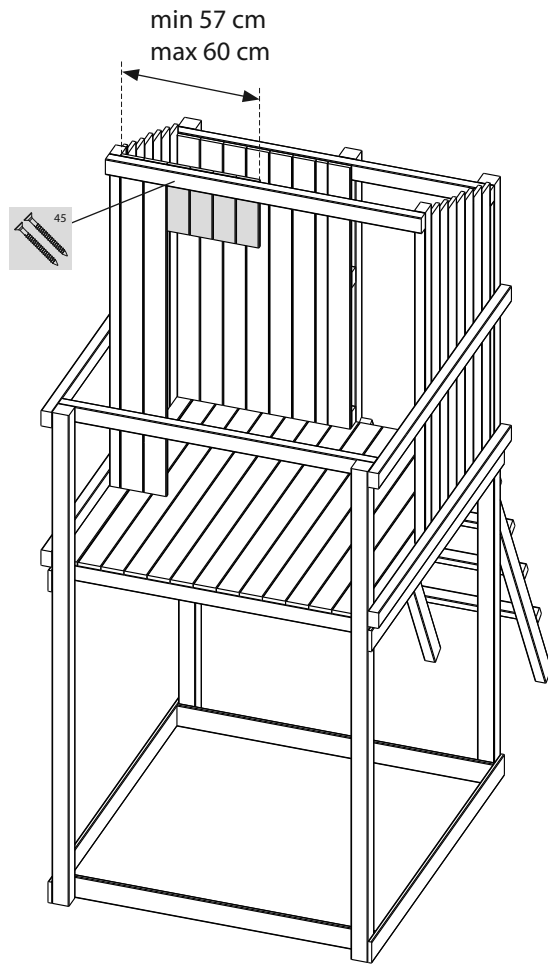

V 3x/4x
45
4x



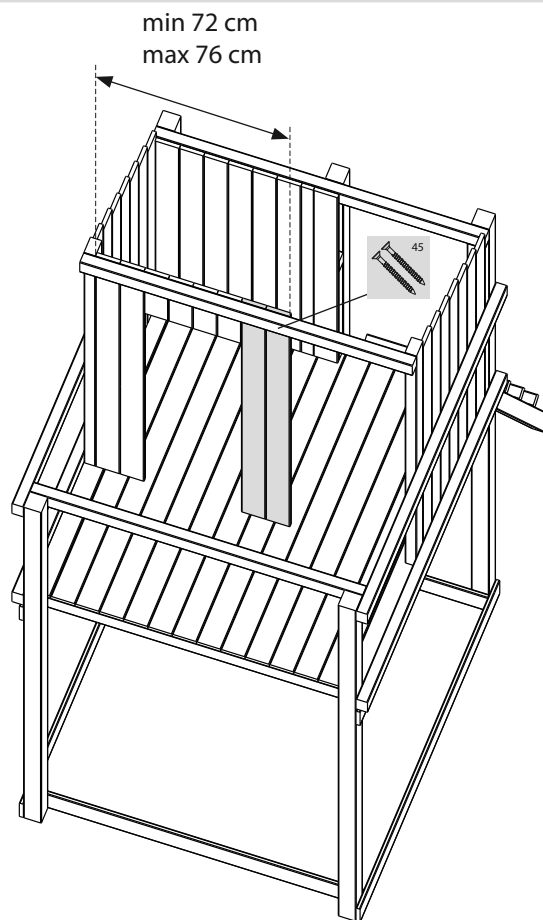

P 1x/2x
45
2x



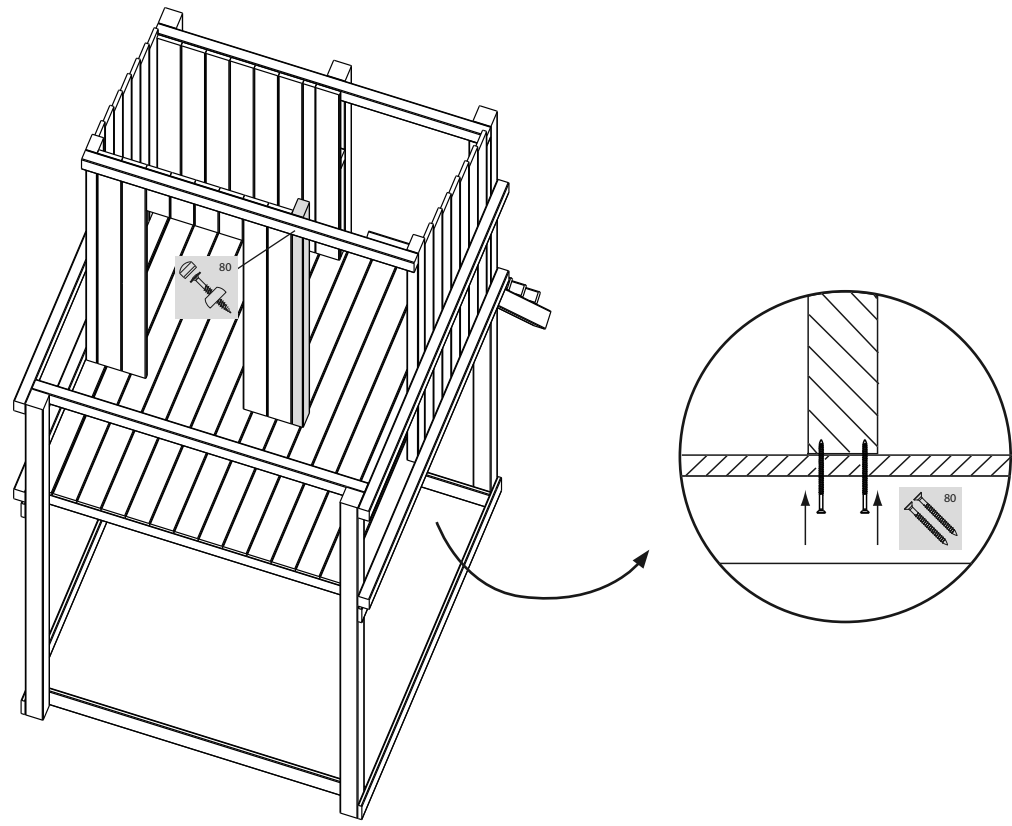

-  **1x**
-  **1x**
-  **1x**



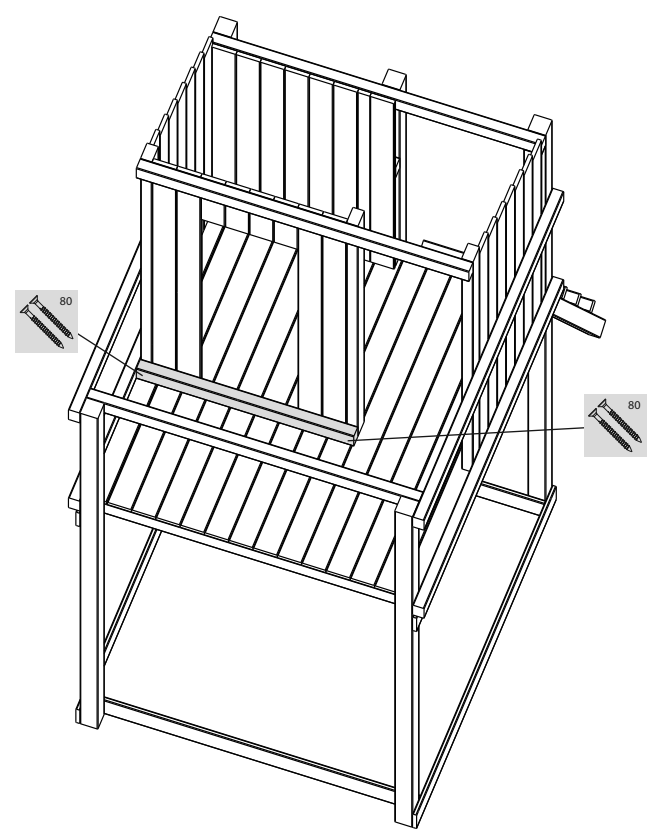

-  **1x**
-  **2x**

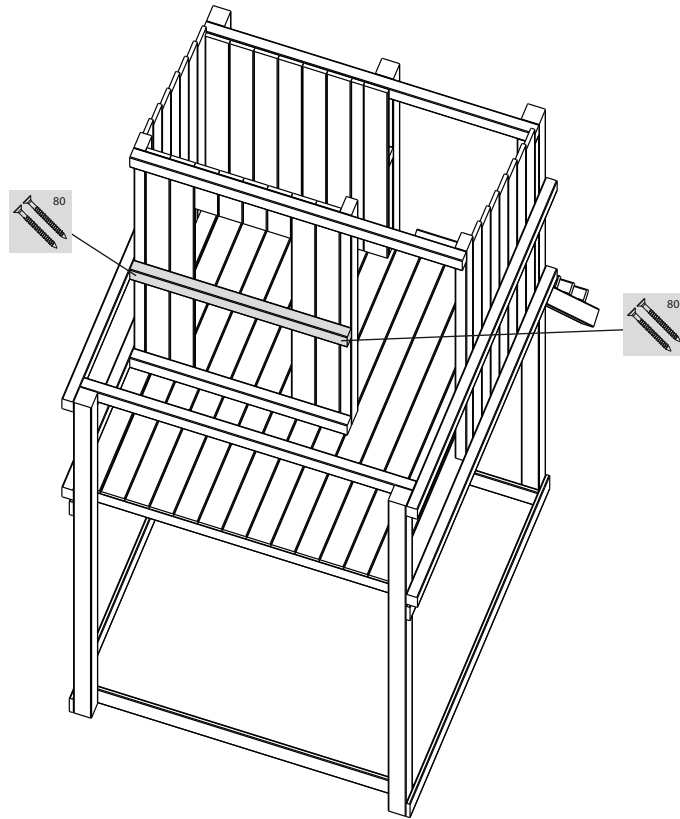

-  **1x**
-  **2x**



-  **3x/4x**
-  **10x/16x**

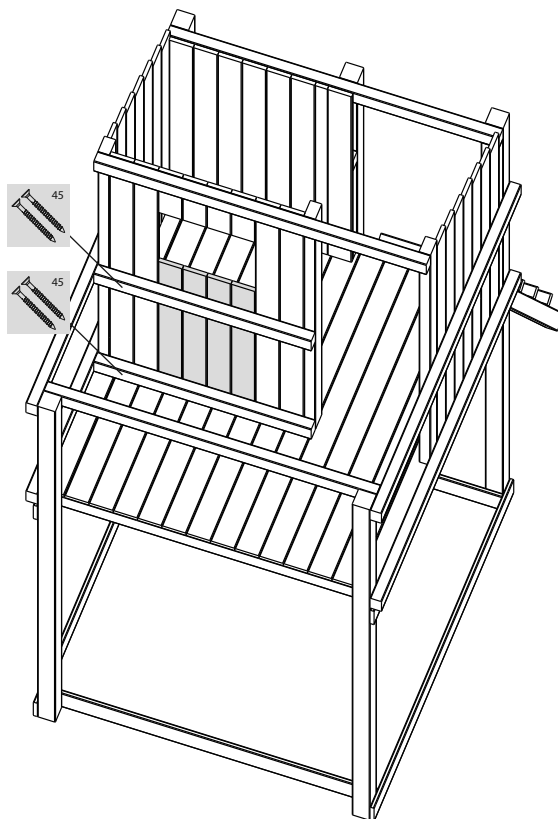

N 1x
45 3x

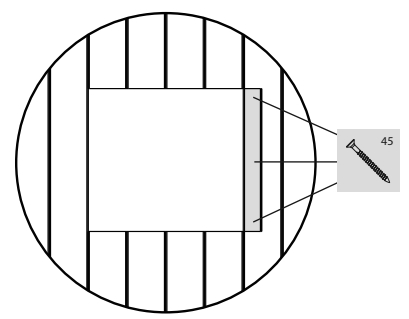
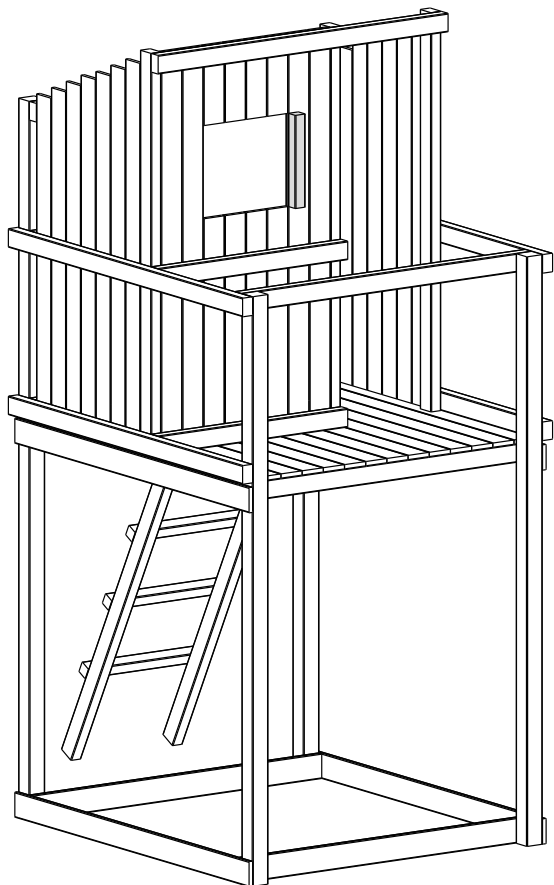

15a





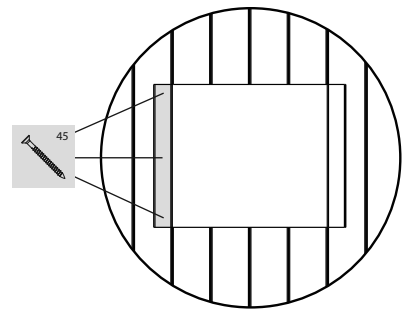
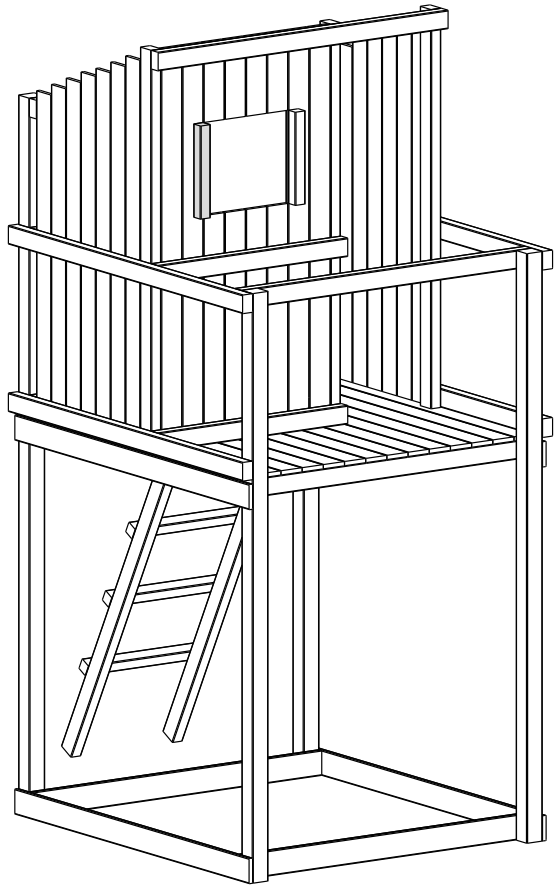

N 1x
45 3x

15b

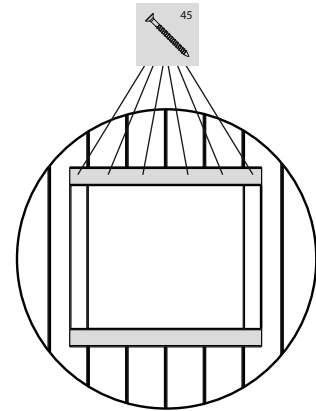
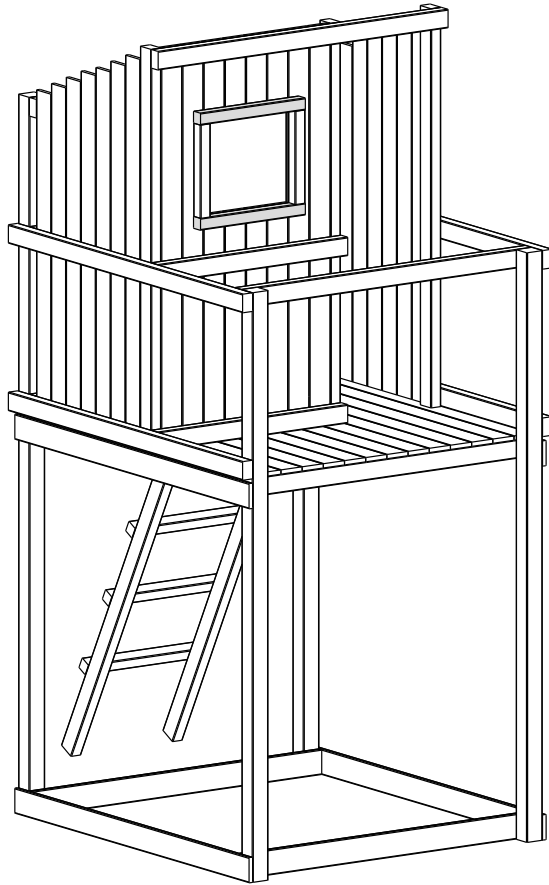





-  **2x**
-  **12x**

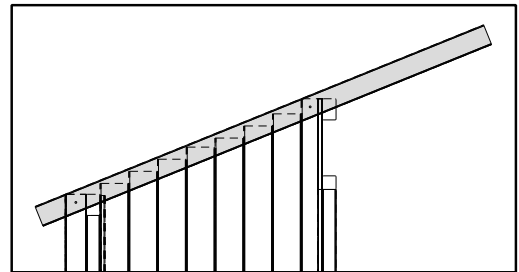
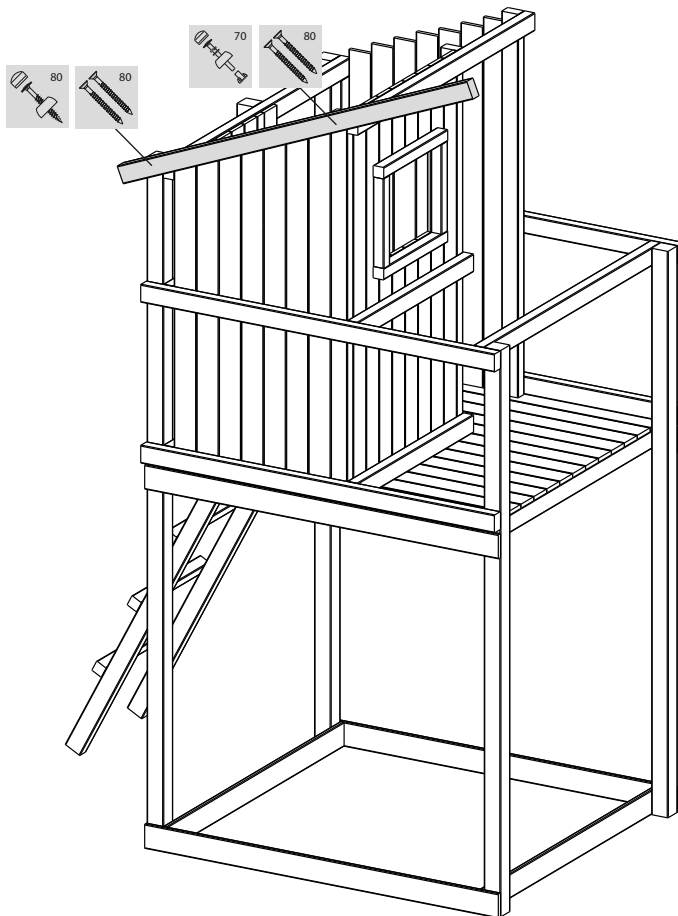



-  **1x**
-  **2x**
-  **1x**
-  **1x**



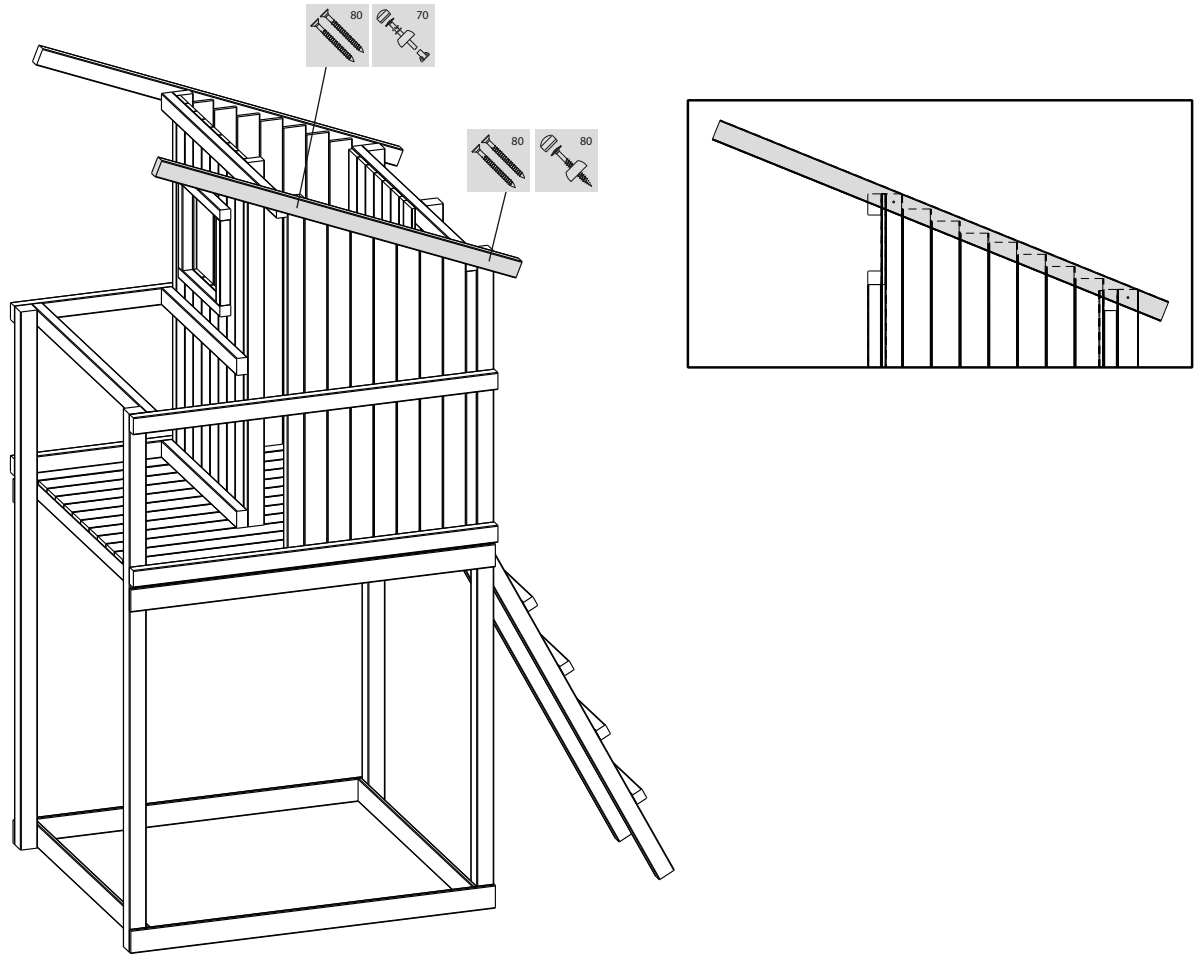

-  1x
-  2x
-  1x
-  1x



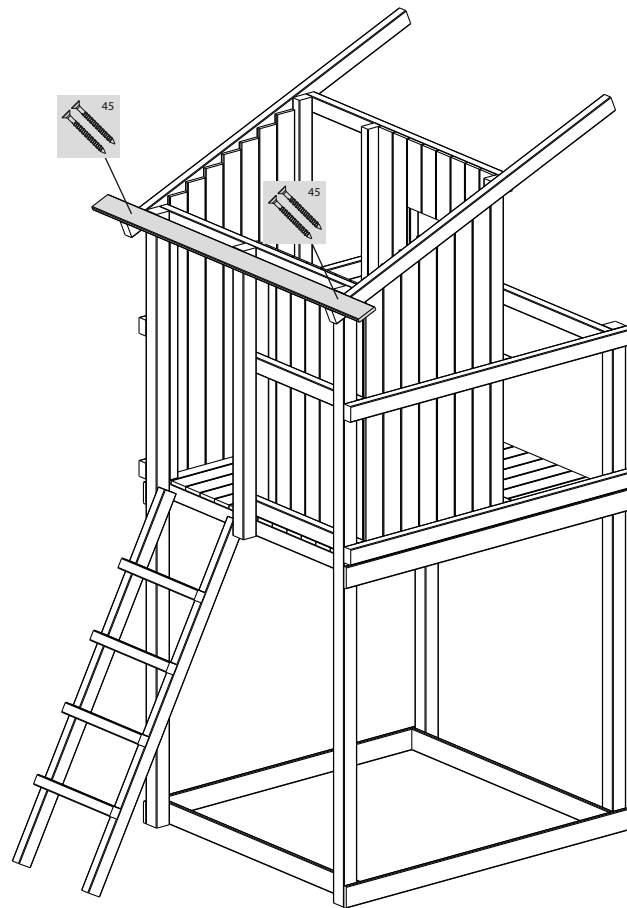

-  1x
-  2x



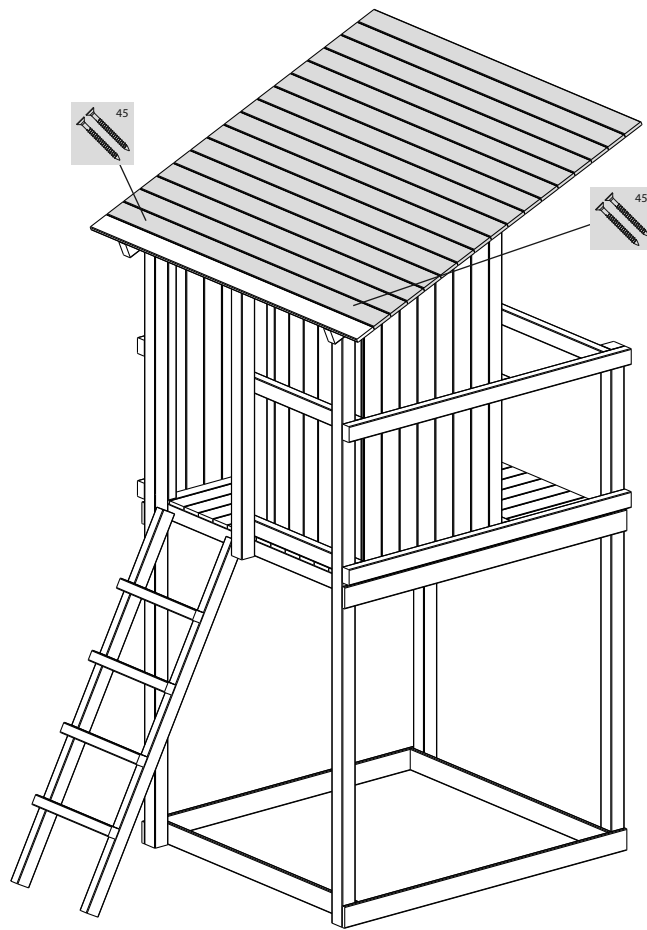

-  10x/16x
-  32x



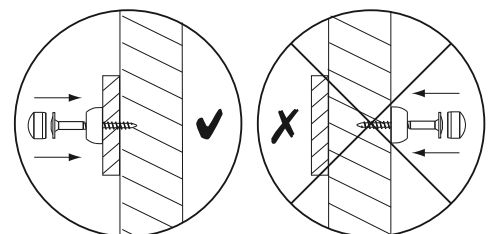
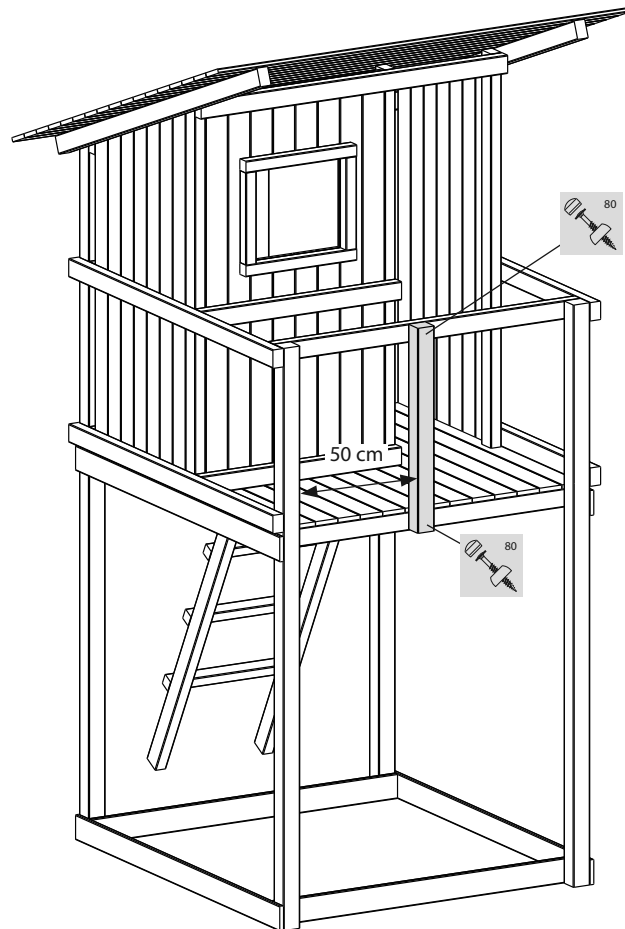

-  1x
-  2x



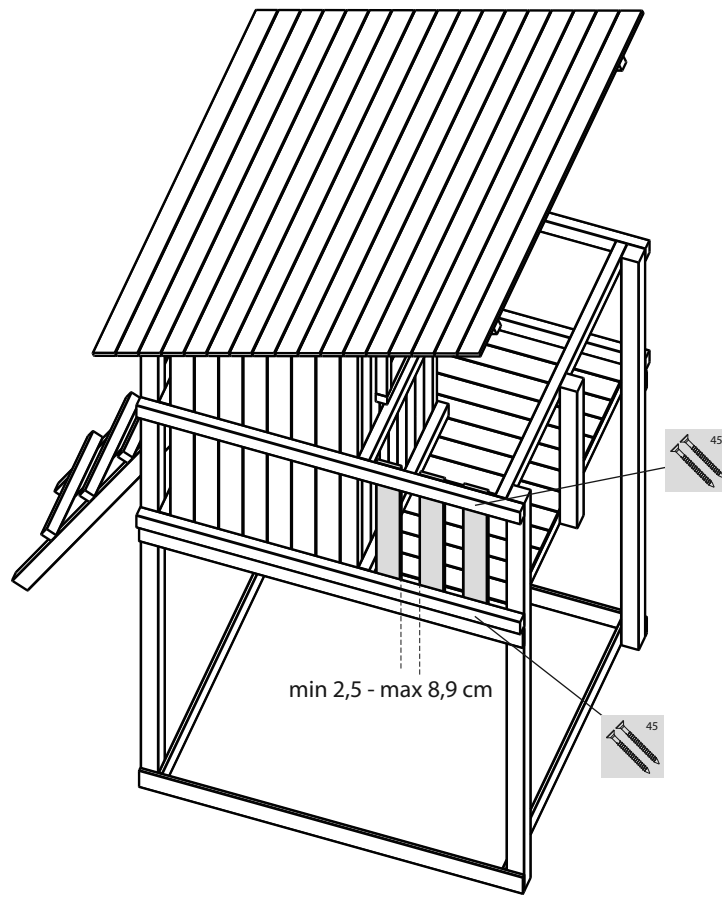

 2x/3x
 6x

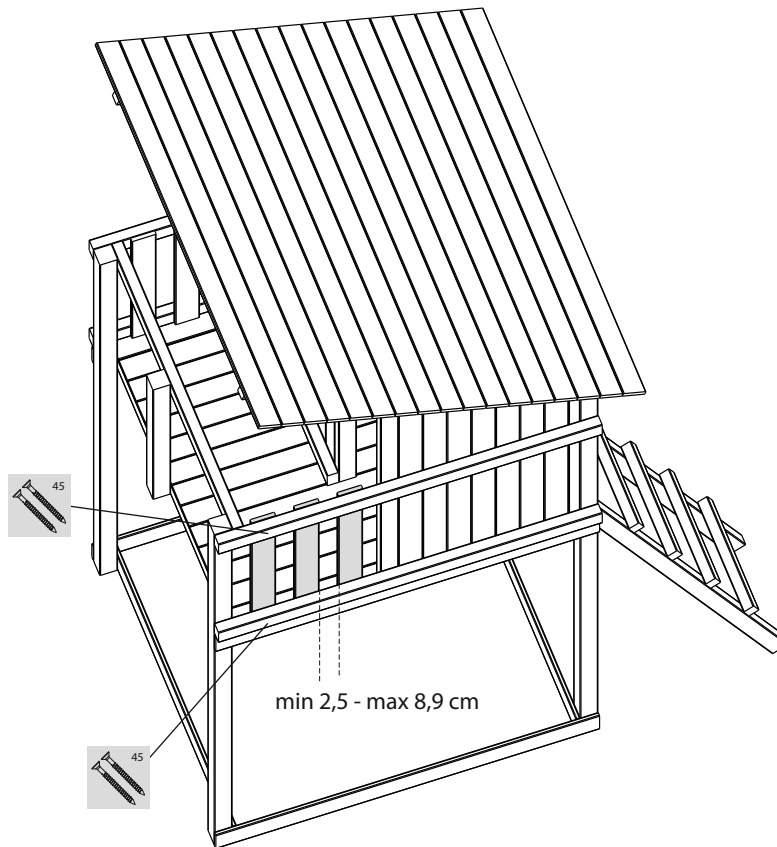

 2x/3x
 6x



-  **P** 2x
-  **R** 2x
-  ⁴⁵ **8x**

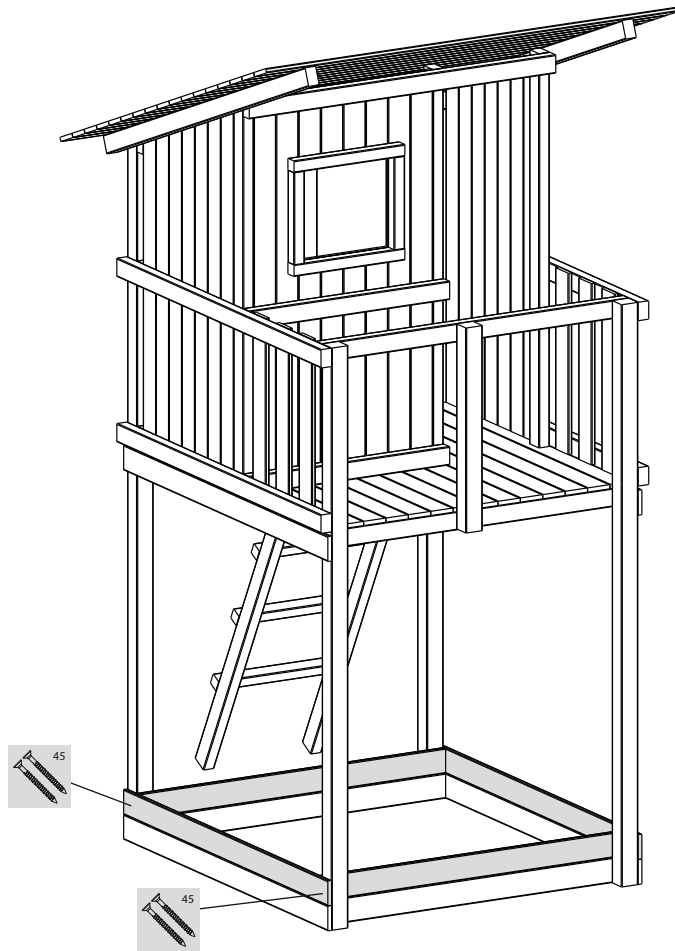

-  **3x**

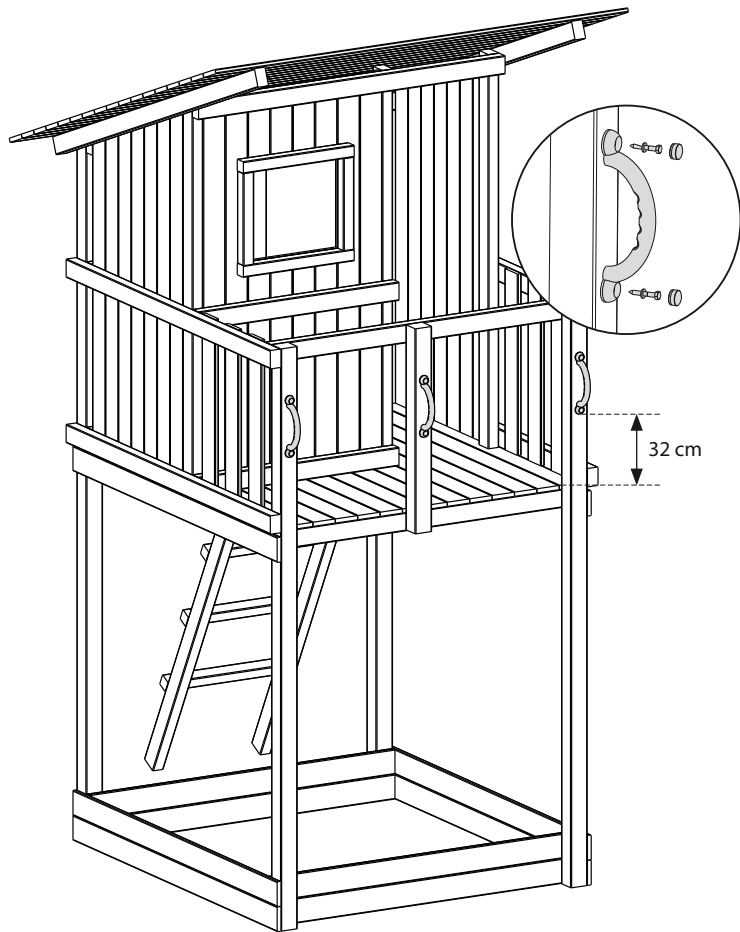



2x

21b

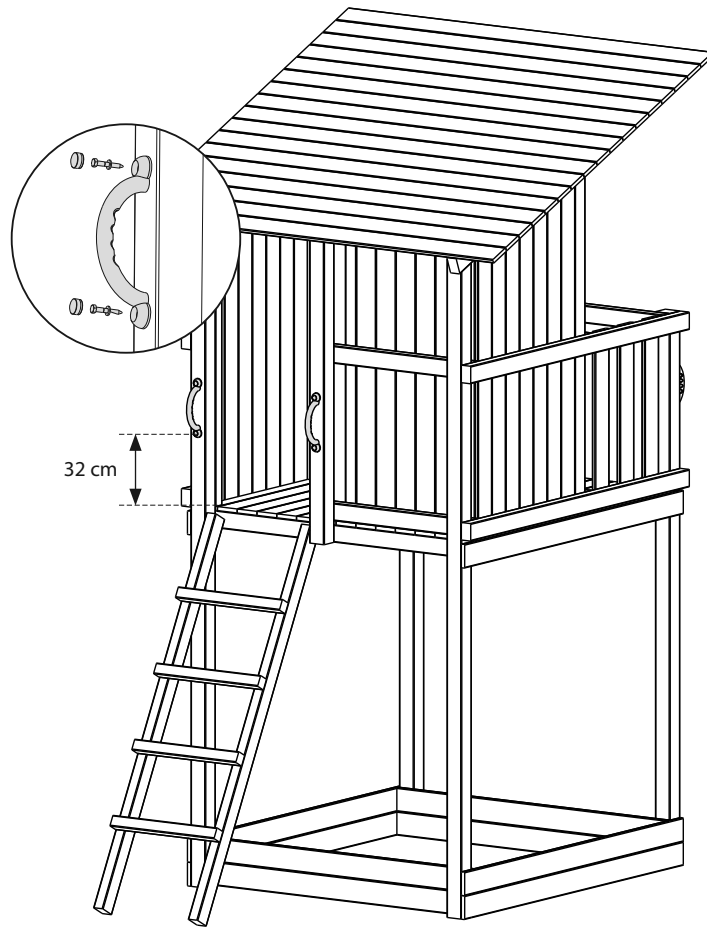



2x

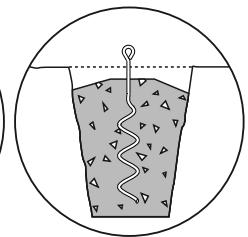
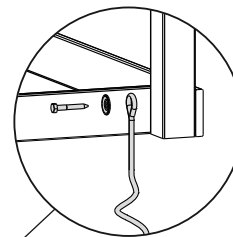
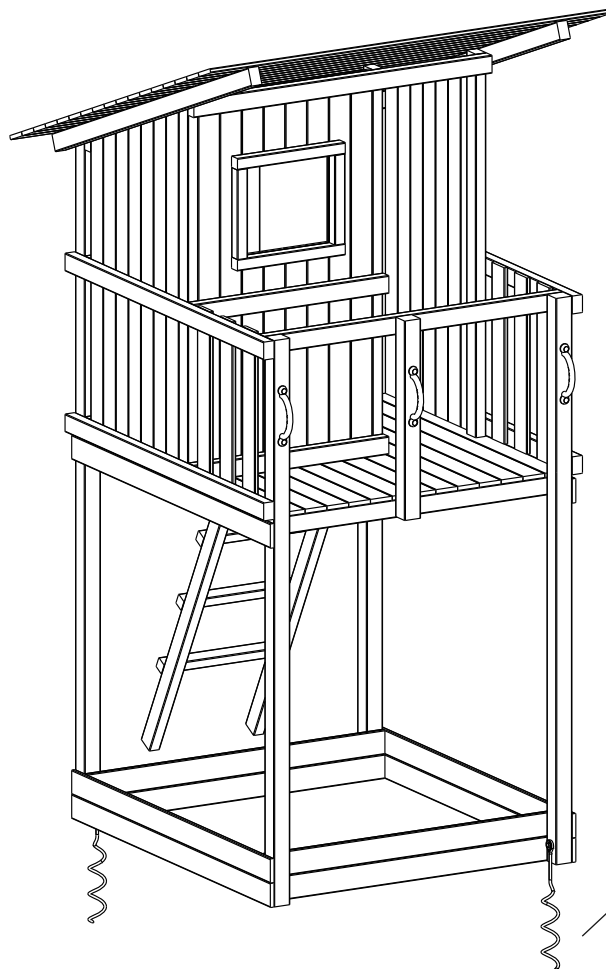

2x

22



-  1x
-  2x

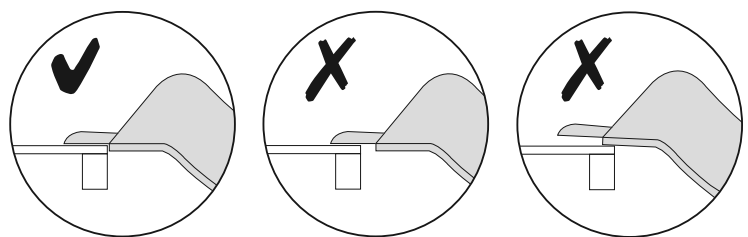
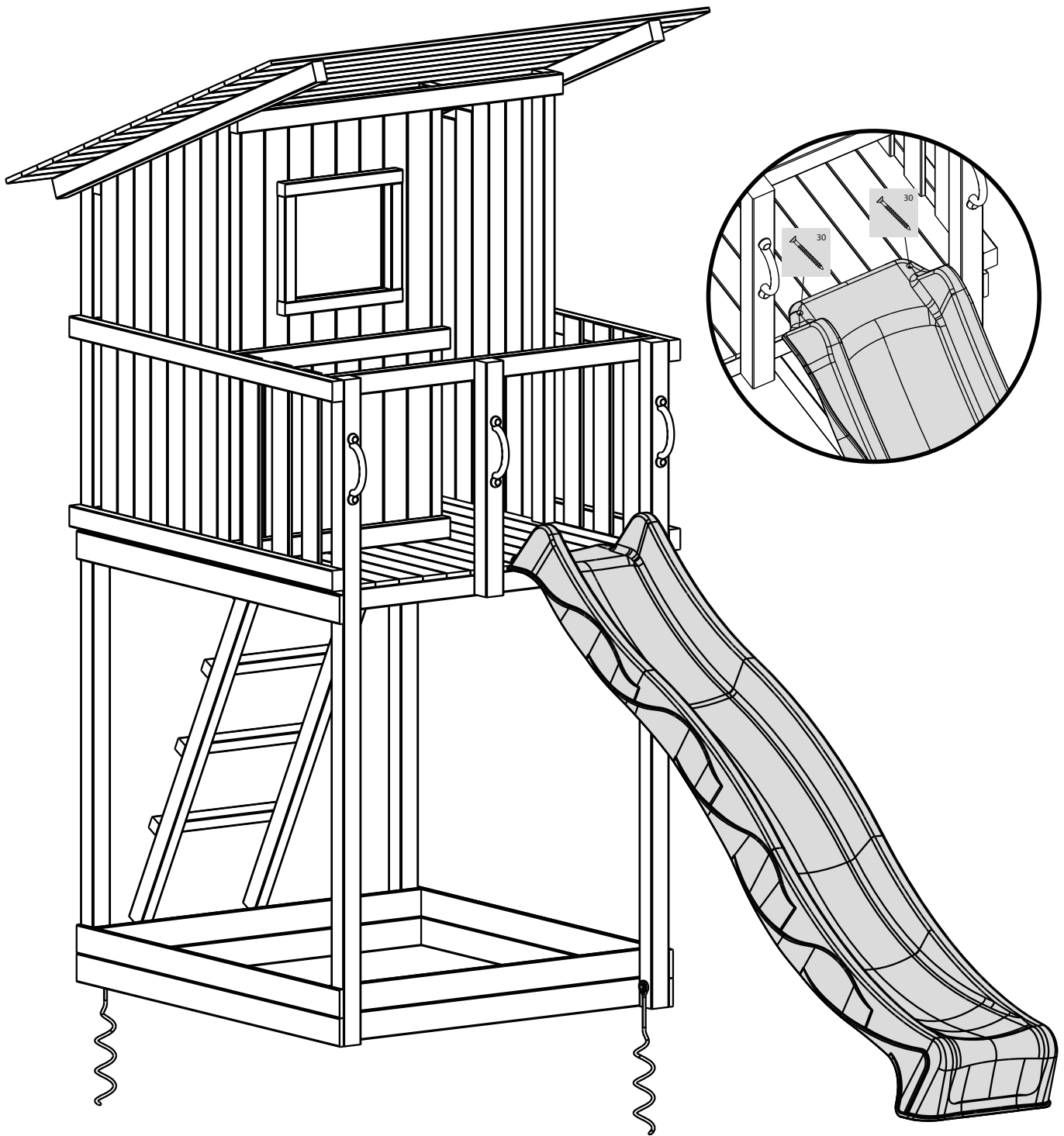

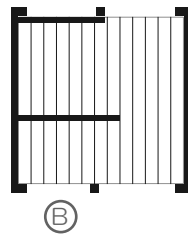

+

slide
@wall
@ramp
@net
@bridge





blue rabbit

Blue Rabbit 2.0®
Hemelrijken 8
B-2890 Sint-Amands
BELGIUM

www.bluerabbit.be